



EUROPEAN TOUCH™

The World's Finest Pedicure Spas

**OWNER'S MANUAL
FORTE SPA
&**

ALTERA SPA

CRYSTAL CLEAN PIPE-FREE

&

TRADITIONAL WHIRLPOOL

EUROPEAN TOUCH - LIMITED CONDITIONAL* WARRANTY

European Touch Holdings, Inc. ("European Touch") conditionally warrants your whirlpool pedicure spa (the "Pedicure Spa") in accordance with the terms and conditions set forth below for a period of one (1) year commencing on the original date of shipment of the Pedicure Spa to you. The warranty only applies to the Pedicure Spa's original end-user owner or customer (the "Customer"). **This Conditional Warranty is non-transferable and replaces any warranties previously published by European Touch.**

If examination of the Pedicure Spa by European Touch during the applicable warranty period shows it to have a defect in material or workmanship, European Touch will, at its option, repair or replace the defective component or part thereof. Further, European Touch may, at its discretion, replace a defective component or part with a refurbished component or part, or may replace the Pedicure Spa with a refurbished pedicure spa. If European Touch elects to replace the Pedicure Spa, the replacement pedicure spa must be comparable in style and size to the Pedicure Spa. The Customer shall bear all charges incurred for the shipment to it of replacement components or parts, or a replacement pedicure spa, and the cost of all labor incurred in repairing defects in the Pedicure Spa or repairing or replacing any of its defective components or parts.

The foregoing limited warranty does not apply:

- To the Pedicure Spa, or any components or parts thereof, if subjected to misuse or neglect or if accidentally or intentionally damaged.
- To the Pedicure Spa, or any components or part, if altered or modified in any way.
- To any expenses incurred by the Customer or any third party, including labor or material, during investigation, removal or reinstallation of the Pedicure Spa or any defective components or parts.
- To any damage to or impairment of the Pedicure Spa, or any components or parts thereof, caused by any casualty, including without limitation, accident, fire, wind, floods, acts of nature or attempted theft.
- To any workmanship of a fabricator (other than European Touch) or installer of the Pedicure Spa.
- If damage to pump parts and/or motor parts is due to obstructed plumbing.
- If the Pedicure Spa is removed from its place of initial installation.
- To staining, fading, or discoloration of any portion of the Pedicure Spa caused by water additives or improper water treatment.
- To staining, fading or discoloration of the Pedicure Spa's upholstered seat, armrests or footrests.
- To malfunctions or damage caused by improper installation of the Pedicure Spa, including, but not limited to, failure to meet local, state, or local plumbing, electrical and building codes.
- To damage resulting from a person standing in the Pedicure Spa's basin or other similar stress to that basin.
- To freight damage.
- To damage incurred to the Pedicure Spa while in possession of any party other than European Touch.

This foregoing conditional limited warranty is also conditional upon:

- The Pedicure Spa being installed by a licensed professional in accordance with European Touch's installation instructions.
- The proper use of cleaning and sanitizing solutions in accordance with the manufacturer's instructions, or state board. It must be noted that repeated use of concentrated sodium hypochlorite solutions (chlorine bleach), concentrated ether solutions, or acetone will damage chrome and plumbing components and will void the limited warranty on those

parts. European Touch recommends that you thoroughly read labels and use sanitizing products void of these chemicals.

- Use of this pedicure spa for functions it was not created for, including, but not limited to, ionic detox or any process that operates by reverse electroplating; this use will destroy plated parts and void the warranty.
- Shipment, if requested, to European Touch of Pedicure Spa parts or components thought to be defective. Parts or components may only be returned if authorized in advance by European Touch. All returns must be freight prepaid.
- Determination by European Touch, in its reasonable discretion, that there exists a defect in material or workmanship.

Repair or replacement of any part or component under this Limited Warranty, or furnishing a replacement pedicure spa, shall not extend the duration of the warranty with respect to such repaired or replaced part beyond the stated warranty period. When a part or component is replaced, it will be under warranty for 90 days, or for the remaining life of original warranty, whichever period is greater.

Customer agrees by using the Pedicure Spa that

- **THE OBLIGATION OF EUROPEAN TOUCH SHALL NOT EXTEND TO INDIRECT OR CONSEQUENTIAL DAMAGES OR INJURY WHICH MAY RESULT FROM SUCH USE**
- that the obligations of European Touch are limited to those set forth herein
- this warranty is limited to the original owner/end-user and is non-transferable
- European Touch shall not be liable for any other obligations or liabilities, including, but not limited to: obligations or liabilities arising out of breach of contract or warranty, negligence, or other tort or any theory of strict liability with respect to the Pedicure Spa or parts or components thereof or any acts or omissions of European Touch
- Any assistance European Touch provides to the Customer outside of terms, limitations, or exclusions of this limited warranty will not constitute a waiver of any of the foregoing terms, limitations, or exclusions, nor will such assistance extend or revive the warranty.

THIS LIMITED WARRANTY IS IN LIEU OF ALL OTHER WARRANTIES, EITHER EXPRESS OR IMPLIED, AND ALL SUCH OTHER WARRANTIES, INCLUDING WITHOUT LIMITATION, IMPLIED WARRANTIES OF MERCHANTABILITY OR FITNESS FOR A PARTICULAR PURPOSE, ARE HEREBY DISCLAIMED AND EXCLUDED FROM THIS LIMITED WARRANTY. NO DEALER OR OTHER PERSON HAS ANY AUTHORITY TO BIND EUROPEAN TOUCH TO CHANGES OR ADDITIONS TO THIS WARRANTY OR ITS PRODUCTS. ACCORDINGLY, EUROPEAN TOUCH IS NOT RESPONSIBLE FOR ANY SUCH OUTSIDE WARRANTIES OR REPRESENTATIONS.

IN NO EVENT SHALL EUROPEAN TOUCH BE LIABLE IN ANY WAY FOR ANY CONSEQUENTIAL, SPECIAL, OR INCIDENTAL DAMAGES OF ANY NATURE WHATSOEVER, OR FOR ANY AMOUNTS IN EXCESS OF THE SELLING PRICE OF THE PEDICURE SPA OR ANY COMPONENTS OR PARTS THEREOF FOUND TO BE DEFECTIVE. THIS LIMITED WARRANTY GIVES THE CUSTOMER SPECIFIC LEGAL RIGHTS. THE CUSTOMER MAY ALSO HAVE OTHER RIGHTS WHICH MAY VARY BY EACH JURISDICTION.

Should your Pedicure Spa require service due to a defect or malfunction, please contact:

European Touch – Technical Support
800.626.6912 | 414.357.7016 | f: 414.357.6360
email: service@europeantouch.com
website: www.europeantouch.com



Certificate of Compliance

For

European Touch

8301 W. Parkland Court
Milwaukee, WI
U.S.A. 53223

For Compliance of:

Equipment: Whirlpool Pedicure Spa
Model No.: SOLACE – PF & SOLACE – PF PDP
Rated: 220-240VAC, 50Hz, 7.5A

To the following standard(s):

EN60335-1:2002
EN60335-2-32:2002
EN 55014-1 (Generic): 2001
EN 55014-2 (Generic): 2003
EN61000-4-2 (Criteria C): 2001
EN61000-4-3:2002
EN61000-4-4: 1995
EN61000-4-5: 2001
EN61000-4-6: 2001
EN61000-4-11: 2004

Project No.: 8311-1
Issue Date: December 30, 2005
Expiry Date: December 30, 2008

Issued by:

Kavinder Dhillon
President

ONE STOP GLOBAL CERTIFICATION SOLUTIONS





EUROPEAN TOUCH™
OWNERS MANUAL For
Whirlpool Pedicure Spa Models:
FORTE and ALTERA
IMPORTANT INFORMATION

Serial Number: _____

W/O Number: _____

Installed by: _____

Installation Date: _____

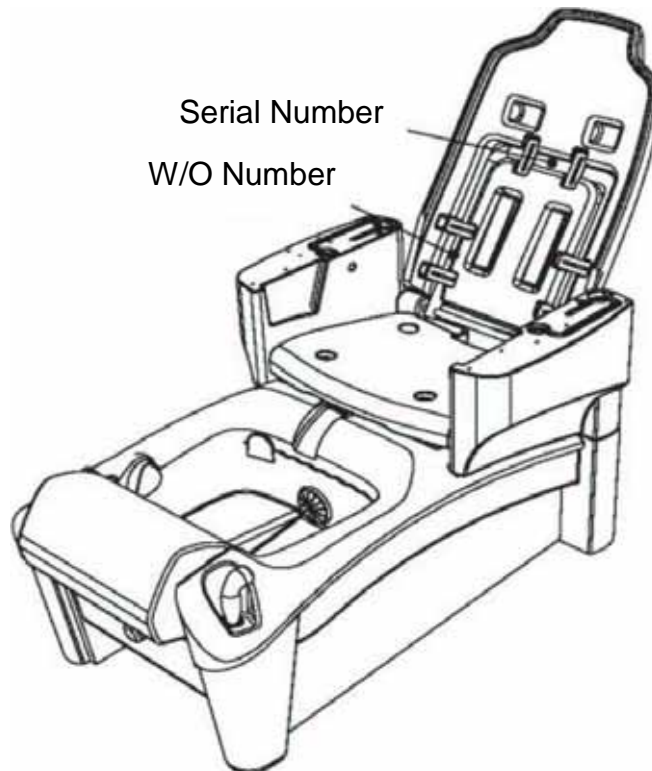

Note: Vietnamese and Korean translations available upon request.



EUROPEAN TOUCH™

TABLE OF CONTENTS

EUROPEAN TOUCH - LIMITED CONDITIONAL * WARRANTY	ERROR! BOOKMARK NOT DEFINED.
CERTIFICATE OF COMPLIANCE	4
IMPORTANT INFORMATION	5
INTRODUCTION.....	7
IMPORTANT REQUIREMENTS	7
PRECAUTIONS	7
HEALTH RISK WARNING	7
INSTALLATION SPECIFICATIONS SUMMARY.....	8
LOCATION AND SUPPORT.....	8
IMPORTANT INSTALLATION AND UTILITY INFORMATION.....	9
DIMENSIONAL DRAWINGS	10
CRYSTAL CLEAN™ PIPE-FREE® AND TRADITIONAL WHIRLPOOL (WITH JETS)	10
CRYSTAL CLEAN™ PIPE-FREE®	11
TRADITIONAL WHIRLPOOL (WITH JETS)	12
SPECIFICATIONS	13
ATTACHING THE SEAT BACK	14
UNPACKING THE CUSHIONS	15
REMOTE CONTROL CONFIGURATIONS	15
ATTACHING THE CUSHIONS.....	16
COMPONENT REFERENCE.....	17
PEDICURE PRODUCT GUIDELINES	17
CRYSTAL CLEAN™ PIPE-FREE® SPA - OPERATING INSTRUCTIONS	18
CRYSTAL CLEAN™ PIPE-FREE® SPA - CLEANING AND DISINFECTING PROCEDURES.....	19
TRADITIONAL WHIRLPOOL (WITH JETS) - OPERATING INSTRUCTIONS	20
TRADITIONAL WHIRLPOOL (WITH JETS) - SPA CLEANING AND DISINFECTING PROCEDURES	21
REMOVAL / REPLACING JET PARTS.....	22
REMOVAL / REPLACING SUCTION COVER.....	22
REMOVING / REPLACING DRAIN HANDLE	23
REMOVING / REPLACING IMPELLER	23



EUROPEAN TOUCH™

INTRODUCTION

Thank you for selecting EUROPEAN TOUCH, the leading designer, manufacturer, and marketer of pedicure spas in North America. The Forte and Altera pedicure spas (herein referred to as pedicure spa) are innovative whirlpool pedicure spas that have been designed to serve you dependably for many years. Please take time to thoroughly read this entire manual before installation and use. If you have any problems or have questions regarding your pedicure spa, please contact EUROPEAN TOUCH's Technical Support Department at **1-800-626-6912**, Monday through Friday 8 AM to 5 PM CST. After hours calls are recorded and attended to the next business day.

IMPORTANT REQUIREMENTS

EUROPEAN TOUCH requires that you contact a local, licensed plumber and licensed electrician to install your new pedicure spa. Installation must be in compliance with all your local and state building codes. Your pedicure spa cannot operate efficiently or safely unless it is provided with adequate electrical power, sufficient water pressure, proper water temperature, and required drainage capabilities. Contact your local building inspector for information and local code compliance procedures that need to be followed when having your pedicure spa installed. Subsequent inspections and approvals that may be required are the responsibility of the purchaser. **(See limited warranty regarding incidental or consequential exclusions – page 2).**

PRECAUTIONS

- Do not stand in the basin of the pedicure spa!
- Excessive water temperature is dangerous and should be checked before use. Maximum operating water temperature should not exceed 105° F (41° C) and the maximum supply water temperature should not exceed 120°F (49° C).
- Always enter and exit the pedicure spa slowly and carefully.
- Close side arms rests before operating the chair seat movement.
- Never bring or operate any electrical devices into or near the pedicure spa.
- This pedicure spa has a weight capacity of 250 pounds (113.4kg).

HEALTH RISK WARNING

Individuals whose feet or legs are inflamed or have open wounds should not be allowed to use the pedicure spa at any time. Nail technicians should advise clients to consult their physician before using the pedicure spa if there is any sign of fungal infection, swelling, fracture, or persistent pain. In some cases diabetics may experience improved circulation in their feet, but should first consult their physician prior to receiving a pedicure. **If the client experiences any pain or discomfort, immediately discontinue the use of the pedicure spa.**

Your client's massage and pedicure spa experience should be pleasant and comfortable.

INSTALLATION SPECIFICATIONS SUMMARY

Note: Failure to comply with federal, state or local codes and ordinances will result in the warranty being null and void.

As stated, the pedicure spa installation must comply with all plumbing and electrical codes. A licensed plumber and licensed electrician must complete the applicable connections of the pedicure spa.

LOCATION AND SUPPORT

Select a level location. The floor structure beneath the pedicure spa must be capable of supporting the occupied pedicure spa.

For the seat back to fully recline, the pedicure spa base must be mounted a minimum distance from the wall:

Forte model	18" (46 cm)] = "X" dimension, below, by model.
Alterra model	12" (31 cm)	

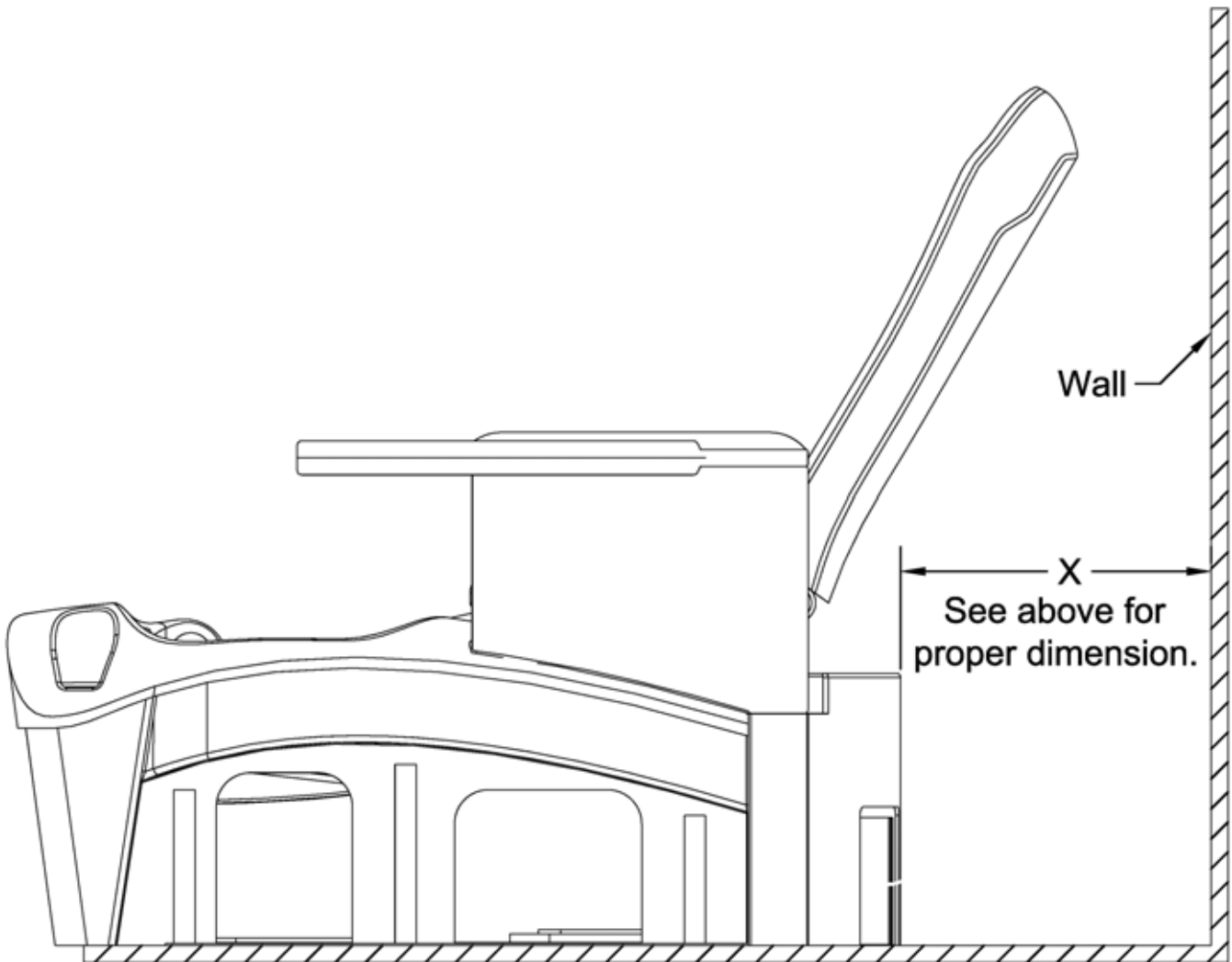

IMPORTANT INSTALLATION AND UTILITY INFORMATION

Electrical Service:

- 110V: A 110V, 60 Hz, 15 Amp GFCI protected grounded circuit must be used to supply power to the pedicure spa. (220V if ordered in 220V configuration)
- 220V: A 220-240VAC, 50Hz, 7.5 Amp GFCI protected grounded circuit must be used to supply power to the pedicure spa per local code.

Water Supply:

All plumbing connections must conform to local codes.

Normal water pressure of 30 to 80 PSI is required to correctly fill the basin to the proper level.

The hot water supply temperature must not exceed 120°F (49° C). Adjust your hot water heater accordingly.

For hot and cold water supply fittings and power drain fittings location, see figure 1 below.

Carefully connect the incoming water supply lines to the appropriate fittings located on the back of the pedicure spa. Shut-off valves are recommended.

Backflow Protection Devices for Faucets with Side Spray: Check valves comply with ANSI/ASME A112.18.3M, A112.18.1M, and CSA B125

ANSI/ASME A112.18.3M (Performance Requirements for Backflow Protection Devices and Systems in Plumbing Fixture Fittings) is applicable to plumbing fixture fittings with outlets not protected by an air gap. Included in the possible range of applications are fittings with hose connected outlets, fittings with pullout spout, hand held showers, shampoo fittings and deck-mounted fittings. ASME A112.18.3M is now referenced in ASME A112.18.1M (Plumbing Fixture Fittings) and CSA B125. Check valves are listed to both standards with the Canadian Standards Association, IAPMO and UL.

ANSI - American National Standards Institute

ASME - American Society of Mechanical Engineers

CSA - Canadian Standards Association

IAPMO - International Association of Plumbing and Mechanical Officials

UL - Underwriters Laboratory

The pedicure spa drain must meet local plumbing codes. **Check valve for drain (not provided) must be installed by a licensed plumber.**

Pedicure spa must be securely fastened to the floor as shown in figure 2 below. Fasten the pedicure spa to the floor with at least two fasteners, one in the middle plastic support and one in the rear plastic support.

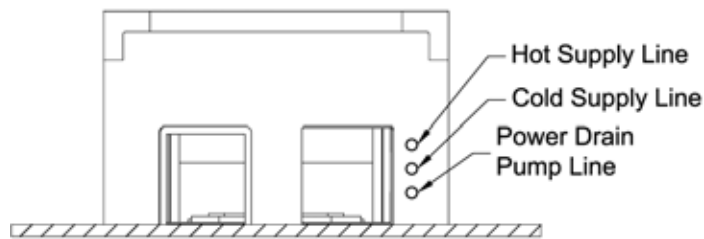

Back of Pedicure Spa
Figure 1

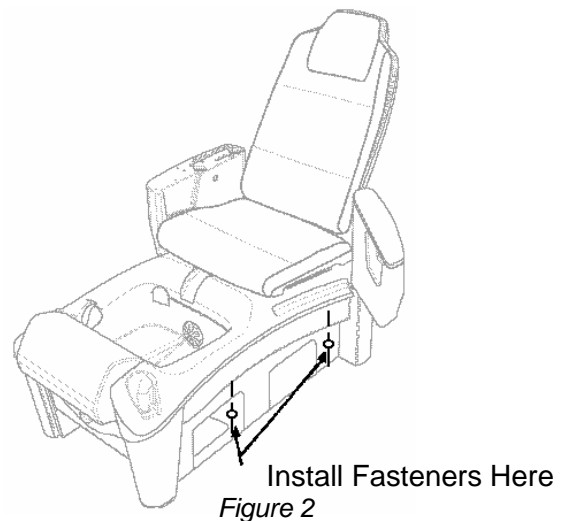

DIMENSIONAL DRAWINGS

CRYSTAL CLEAN™ PIPE-FREE® AND TRADITIONAL WHIRLPOOL (WITH JETS)

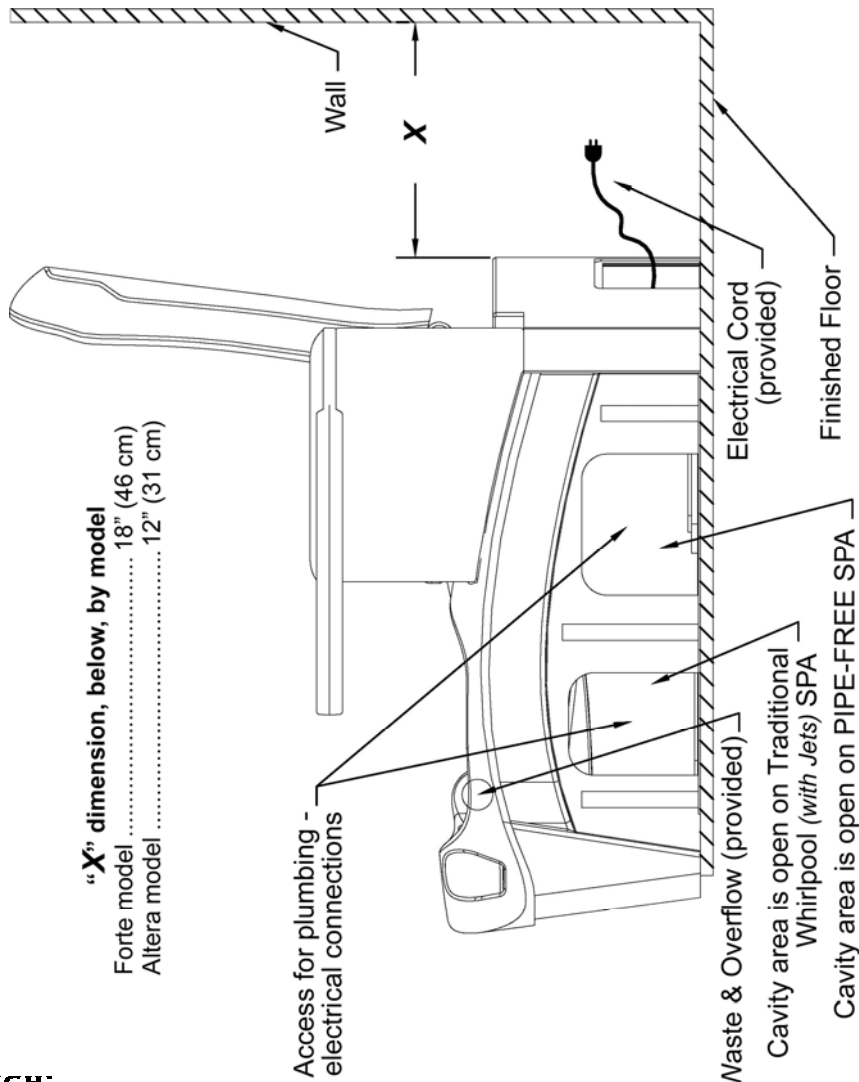
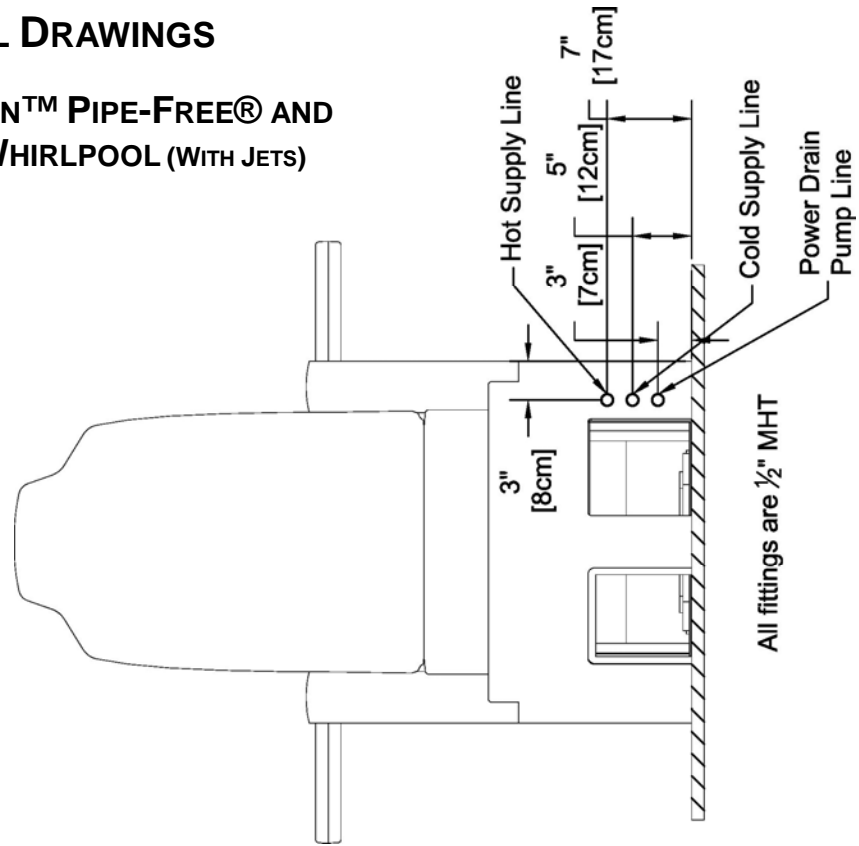

“X” dimension, below, by model
 Forte model 18" (46 cm)
 Altera model 12" (31 cm)



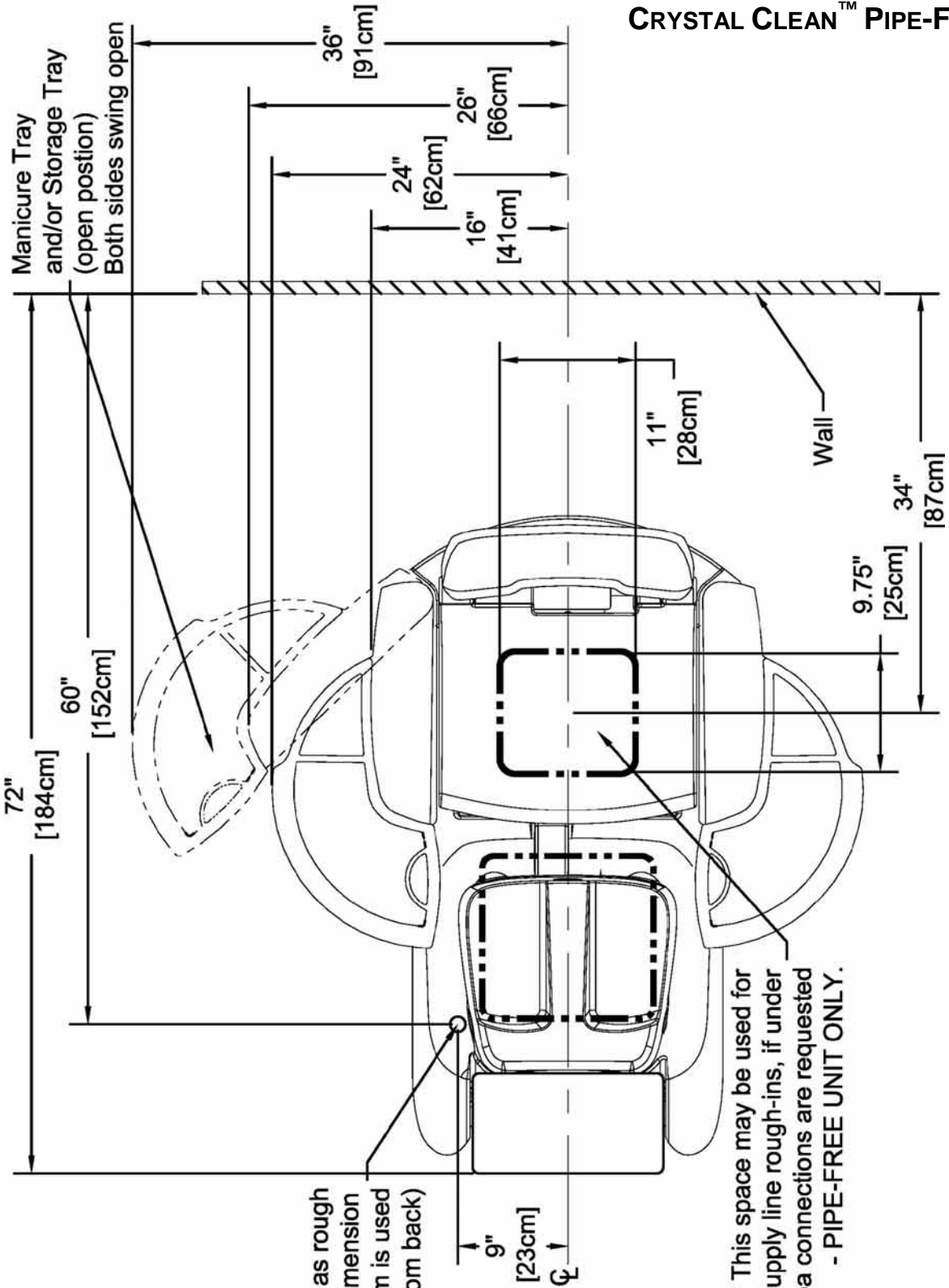

Can be used as rough
in drain dimension
(If power drain system is used
unit is drained out from back)

Plumber This space may be used for
hot & cold supply line rough-ins, if under
spa connections are requested
- PIPE-FREE UNIT ONLY.



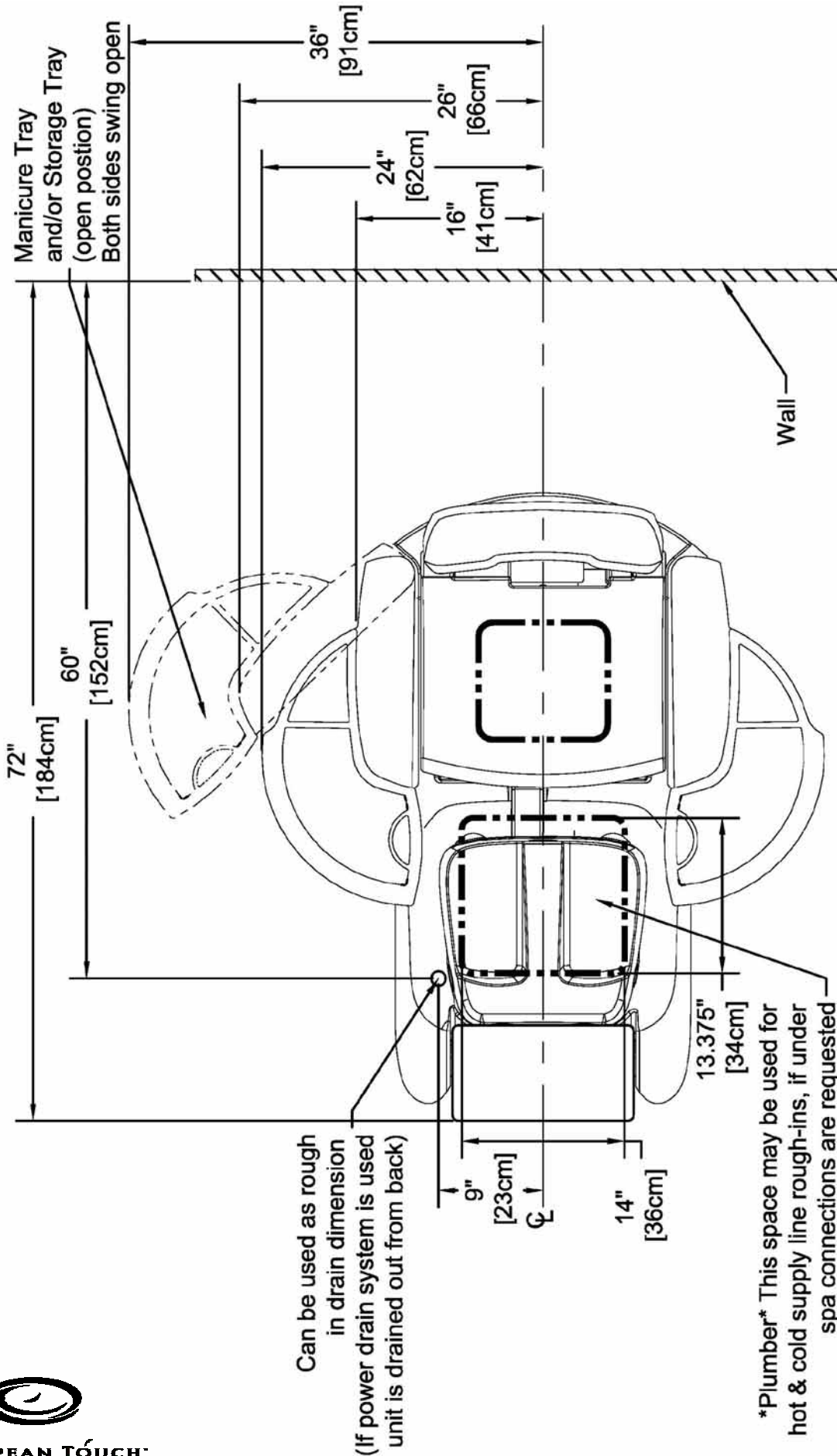

Manicure Tray
and/or Storage Tray
(open position)
Both sides swing open

Wall

Can be used as rough
in drain dimension
(If power drain system is used
unit is drained out from back)

Plumber This space may be used for
hot & cold supply line rough-ins, if under
spa connections are requested
**-TRADITIONAL WHIRLPOOL (WITH JETS)
UNIT ONLY.**



SPECIFICATIONS

Hot and cold water supply lines required (hot and cold shut offs may be installed under pedicure spa base) See pages seven through ten.

Drain installation: references noted on pages seven through ten, can be installed with optional power drain pump or as gravity drain.

Overall dimensions without accessories, seat upright: 54" (138cm) L x 31" (79cm) W x 56" (143cm) H*

Without accessories, seat collapsed: (shipping position): 54" (138cm) L x 32" (82cm) W x 36" (92cm) H*

Shipping dimensions: 55" (140cm) L x 33" (84cm) W x 41" (105cm) H*

Empty weight: 150 lbs (68kg)*

Shipping weight: 205 lbs (93kg)*

Capacity of basin: 5 U.S. Gallons (18.9L) = Traditional Whirlpool (*with Jets*)*

6.5 U.S. Gallons (25.6L) = Crystal Clean™ Pipe-Free®*

Whirlpool pump motor: **110V:** 1/6 HP, 110V, 60HZ (alternate voltages available) (3/4 HP for Traditional Whirlpool - *with Jets*)

220V: 1/6 HP, 110V, 50Hz (alternate voltages available) (3/4 HP for Traditional Whirlpool - *with Jets*)

Forte seat and back motors: 30V DC Linear Actuators. Forte requires 18" (46 cm) of space between pedicure spa and wall with standard actuator.*

Altera seat and back movement: 2 infinitely adjustable lockable gas cylinders for reclining/sliding. The Altera requires 12" (31cm) of space between pedicure spa and wall in order for seat to recline to its fullest extent.*

Massage motor: 12V AC, Adapter included (alternate voltages available)

Power source: **110V:** 110V AC / 15 Amp, 60 Hz (GFCI Protected)

220V: 220-240VAC, 50Hz, 7.5 Amp (GFCI Protected)

Caution: Pedicure spa must be installed by a licensed electrician and a licensed plumber, conforming to all local and national electrical codes.

Construction: Linear Low Density Polyethylene (LLDPE), self-contained, pre-plumbed

Crystal Clean™ Pipe-Free® water massage system (pipe-free pedicure spas): 'underfoot' footplate water massage grooves, no closed loop circulating pipes, 100% fully drained, and cleanable

Hydro-Therapeutic (Jet System: Traditional Whirlpool pedicure spas): PVC, two (2) fully-directional jets, built-in air control

Electrical switches: On/Off switch for whirlpool pump. Hand-held low voltage remote controls for massage motors, heat, and seat/back position. Hot and Cold water supply lines required.

UL listed/CE certified: Complies with ASME/ANSI Whirlpool Bathtub Specs ASME/ANSI A112.19 7M-1995 and A112.19.8M-1995. Backflow Protection Devices for Faucets with Side Spray: Check valves comply with ANSI/ASME A112.18.3M, A112.18.1M, and CSA B125.

Performance Limits:

1. This unit may lose one or more functions when electrostatic contact discharge in excess of 4KV gets into accessible conductive part of the unit and can be restored by resetting the unit.
2. This unit may lose one or more functions when power surge in excess of 2KV is applied to the AC input power port and can be restored by resetting the unit.
3. This unit may lose one or more functions when subjected to fast transient voltages in excess of 0.5KV at 5 KHz repetition frequency and can not be restored.

Limited warranty: One (1) year from date of purchase.

Due to our policy of continuous improvements, all specifications are subject to change without notice.

***Note: All dimensions and weights are approximate**

ATTACHING THE SEAT BACK

Your pedicure spa shipped with the seat bottom and seat back already attached to the base. Follow these instructions to connect the seat back to the pedicure spa:

Forte



Step 1: Remove the hitch and clevis pins located on the seat back mounting bracket on the back of the chair.



Step 2: Slide the seat bracket into the black end on the linear actuator, and line up the holes.



Step 3: Slide the clevis pin through the holes and secure by inserting the hitch pin through the small hole on the clevis pin.

Altera



Step 1: Remove the hitch and clevis pins located on the seat back mounting bracket on the back of the chair.

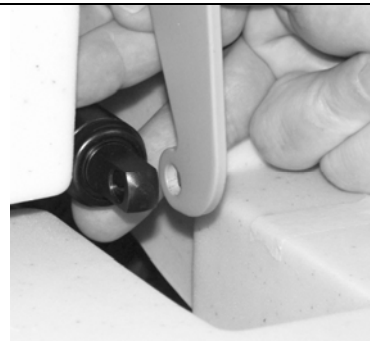

Step 2: Line up the hole on the seat bracket with the hole on the cylinder end.



Step 3: Slide the clevis pin through the holes and secure by inserting the hitch pin through the end hole on the clevis pin.





UNPACKING THE CUSHIONS

Your cushion set is packaged in its own box within the pedicure spa shipping carton. All needed parts are located inside of this box. These include:

- (1) Seat Back
- (1) Seat Bottom
- (2) Arm Cushions
 - **Altera Vibration Massage Only:** The remote and junction box

Please make sure that all parts are removed from the box before discarding the box. If any parts are missing, the customer must contact EUROPEAN TOUCH within 30 days of the delivery date for replacement at 800-626-6912.

REMOTE CONTROL CONFIGURATIONS

<p style="text-align: center;">Forte Seat Movement</p>  <p>Recline Seat Back: Tilt Backward or Forward Recline</p> <p>Move Seat Bottom: Slide Forward or Backward Slide</p> <p style="text-align: center;">EUROPEAN TOUCH</p>	<p style="text-align: center;">Forte/Altera Roller</p>  <p>Indicates that Vibrate Feature is Activated VIBRATE</p> <p>Type of Vibrating Massage: (Surge, Steady, Pulse, Wave) SURGE, STEADY, PULSE, WAVE</p> <p>Increase or Decrease Intensity of vibrating massage INTENSITY, SPEED</p> <p>Timer (15 min or 30 min) 15MIN, 30MIN</p> <p>Indicates that Roller Feature is Activated ROLLER</p> <p>Area of Vibration: Zone 1 = Upper Zone 2 = Lower ZONE 1, ZONE 2</p> <p>Increase or Decrease Speed of vibrating massage.</p>
<p style="text-align: center;">Forte Vibration</p>  <p>Moves through types of vibration ZONE</p> <p>Determines active vibration zone MENU</p> <p>Turn power on/off ON/OFF</p> <p>Increase Speed SPD +</p> <p>Decrease Speed SPD -</p> <p>Display: Which features are active: current speed, heat, and intensity DISPLAY</p> <p>Use to set timer for the active time TIMER</p> <p>Set Heat Level HEAT</p> <p>Increase Intensity INT +</p> <p>Decrease Intensity INT -</p>	<p style="text-align: center;">Altera Vibration</p>  <p>LED Shows Message Zone Activated ZONE I</p> <p>Activates Message Zone 1 HI</p> <p>LED Shows Message Zone Activated ZONE II</p> <p>Activates Message Zone 2 LO</p> <p>When both switches are centered on "Off" the Massage power is off OFF</p>

ATTACHING THE CUSHIONS

All pedicure spa cushions attach to the pedicure spa with Velcro. The Forte and Altera Pedicure spas have cables for the cushions that need to be routed properly. Follow these instructions for attaching the cushions properly to your pedicure spa:



Step 1: Your pedicure spa will come with the Velcro already in place for the seat bottom and the seat back.

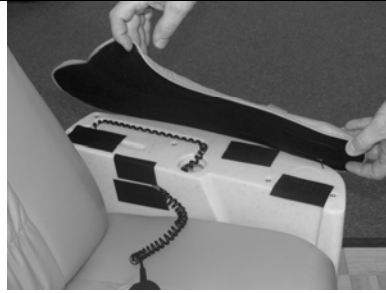

Step 4: Remove the protective film from the Velcro on the bottom of the arm pads. Carefully place the arm pads on the chair arms and slide the remotes under the remote holders on the arm pads.



Step 7: ALTERA VIBRATION ONLY – The Altera cushion remote control comes attached to the junction box.



Step 2: Attach the seat bottom to the chair bottom. Make sure that the cushion is centered on the chair bottom. The arms should be able to close without cushion interference.



Step 5: FORTE ONLY – The remote control and power supply cord are taped together behind the chair. Remove the tape and connect the cords from the cushion to these connectors.



Step 8: ALTERA VIBRATION ONLY – The Altera junction box should be mounted on the back of the seat back. Plug the 2 cushion cords into the red and white receptacles (they can go into either receptacle). The power supply cord plugs into the receptacle next to the remote cord. Plug the power supply into the power strip.



Step 3: Route the seat back cushion cables underneath the chair back and out the back. Center the seatback cushion on the chair back.



Step 6: FORTE ONLY – Route the seat back cables through the hole in the pedicure spa base.



Step 9: The remotes can be slipped into the armrests as shown.

Note: Close side arms rests before operating the chair seat movement.

COMPONENT REFERENCE

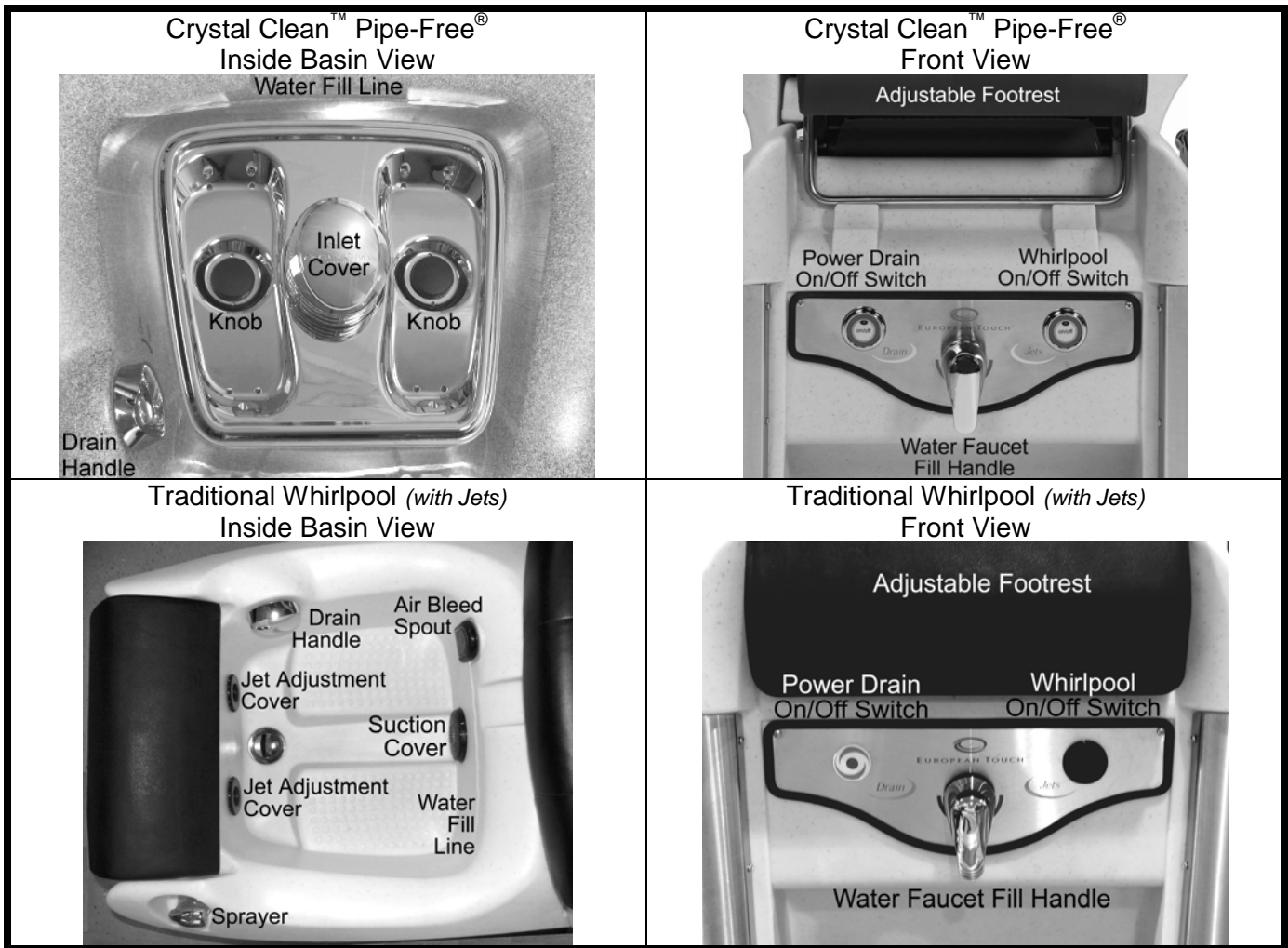

PEDICURE PRODUCT GUIDELINES

Because there are so many different products on the market, it is difficult for us to list all of the pedicure products that are safe to use in our pedicure spas. However, the following guidelines can be used:

- It is your responsibility to understand and follow your state's regulations regarding product usage and disinfecting requirements.
- Do not use any products containing a foaming agent; this will cause excessive foam.
- It has been determined that products containing non-dissolving abrasives (such as sand and sea salts) will not harm the internal component structure of your pedicure spa as long as the entire EUROPEAN TOUCH cleaning requirements are followed without deviation.
- Oil based products may be used in your pedicure spa as long as the cleaning requirements are met.
- Always use pedicure products and cleaning solutions in accordance with each manufacturer's directions.

EUROPEAN TOUCH whirlpool pedicure spas will give you many years of service as long as proper precautions, precise cleaning, and operating instructions are followed. It is the responsibility of the pedicure spa owner to properly clean and maintain the pedicure spa.

If you are experiencing problems cleaning your pedicure spa, please contact the manufacturer of your pedicure products or EUROPEAN TOUCH Technical Support at 800-626-6912.

CRYSTAL CLEAN™ PIPE-FREE® SPA - OPERATING INSTRUCTIONS

Preparing the Pedicure Spa for Operation:

After the pedicure spa is installed and the plumbing and electrical connections are made, clean and disinfect the basin before initial use. Rinse the basin by using the attached water sprayer. Wipe the basin dry with a clean towel.

To Operate the Pedicure Spa, Follow These Easy Steps:

Adding Water to the Pedicure Spa Basin:

1. Close the drain by turning the chrome drain handle counter-clockwise until it stops.
2. Add water to the basin by lifting upward on the water faucet fill handle. Turn the handle in a counter-clockwise direction for cold water or clockwise for warm water as indicated by the red (hot) and blue (cold) markings around the handle (CAUTION: hot water can burn skin). Continue to add water until the fill line is reached. The fill line is indicated by the wavy (~~~~) line in the basin.
3. Turn the off water by pushing the handle downward and center.

Operating the Crystal Clean™ Pipe-Free® System:

The Crystal Clean™ Pipe-Free® System eliminates pipes and jets that can harbor harmful bacteria while at the same time delivering a soothing, quality foot massage. This unique system is driven by an impeller that pulls water through the inlet cover and then forces the water outward through key massage zones in the footplate. The end result is a soothing massage delivered to all areas of the foot: front, back and bottom.

To start or stop the whirlpool, depress the On/Off button labeled “Jets” (**NOTE: An indicator light on the “Jets” button flashes when the footplate is improperly installed, or the basin contains no water. As a result, the whirlpool will not function. To fix, simply check that the footplate is securely fastened or add water to the basin.**)

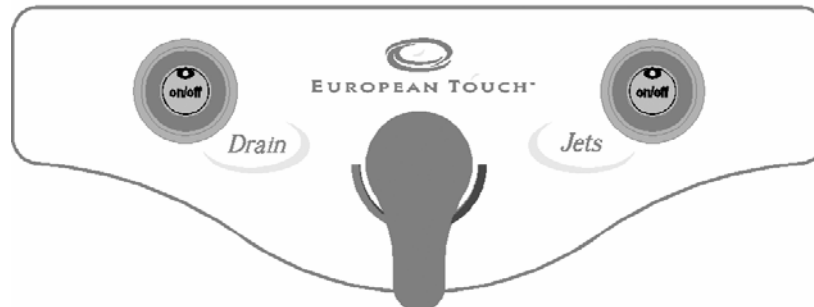

Removing Water from the Pedicure Spa Basin:

First, make certain the whirlpool jets are turned off by turning the On/Off switch counter-clockwise to the “Off” position.

If the pedicure spa is hooked up directly to a floor drain, simply open the drain by turning the drain handle in a clockwise direction until it stops. You should see the water level lowering as water exits the basin.

If the pedicure spa is equipped with the optional Power Drain Pump (PDP) feature, open the drain by turning the drain handle in a clockwise direction until it stops. Press the button marked “Drain” on the front panel. The water level will lower as water is pumped out of the basin. Turn the pump off by pressing the “Drain” button on the front panel once the basin is fully drained (**NOTE: the PDP will automatically shut off after 2-1/2 minutes. We recommend turning off the pump manually if all water has drained before automatic shut-off. Drain pump may overheat if operated more than 10 minutes in a 45 minutes period.**)

Warning:

It is extremely important to follow the cleaning instructions located on the following page. Failure to clean the pedicure spa adequately can result in serious health issues for your clients as well as the nail technician. Failing to clean your pedicure spa may also cause the pedicure spa to not work properly. Always consult your local and state codes concerning pedicure chair cleaning for further requirements.

CRYSTAL CLEAN™ PIPE-FREE® SPA - CLEANING AND DISINFECTING

PROCEDURES

Always check with your state board for required cleaning and disinfecting procedures.

It is extremely important to clean and disinfect your pedicure spa **after each pedicure, after the last pedicure of the day, and once a week for overnight cleaning.** Regular cleaning will help keep your pedicure spa in good working condition. Proper and continuous cleaning will kill harmful bacteria and germs that can cause infection.

To clean the pedicure spa, follow these easy steps:

After Each Pedicure:

1. Drain water from the pedicure spa by turning the drain handle to the "Open" position.
2. Loosen the footplate by turning the footplate Knobs in a counter-clockwise direction. Remove the footplate from the basin by lifting upward on the inlet cover. **(NOTE: Gently press down on the footplate center when loosening the footplate Knobs, as this will relieve pressure and help loosen the Knobs.)**
3. **Remove all debris from the basin.**
4. Clean all the surfaces of the basin and all components, as well as the top and bottom of the footplate and both Knobs. Use low-sudsing soap or detergent and a non-abrasive brush. Remove all visible residue from the inside of the basin and all other components. Clean off sensor on bottom of basin.
5. Rinse the basin with clean water using the sprayer.
6. Disinfect all components, surfaces, basin, top and bottom of footplate, and footplate Knobs with an EPA-registered disinfectant, in accordance with your state board requirements. ***EPA disinfectants require ten-minute contact.**
7. Rinse the basin again with clean water using the sprayer.
8. Thoroughly dry the basin and all other components with a clean towel.
9. Replace the footplate and secure by simultaneously turning both footplate Knobs in a clockwise direction. **(NOTE: When replacing the footplate, carefully align the mounting studs with the mounting holes. Tighten each knob until snug. Be careful not to over-tighten, as this can damage the Knobs.)**

After Last Pedicure of the Day:

1. Drain water from the pedicure spa by turning the drain handle to the "Open" position.
2. Remove the drain cover as shown on page 21. Remove the impeller as shown on page 21. **Remove all debris.** Then wash with low-sudsing soap or detergent using a soft brush. Disinfect the impeller and drain cover as well as the area behind the drain cover. Replace drain cover and impeller.
3. Next repeat steps two through seven above as in "After Each Pedicure."
4. After all components are put back into place, fill basin with clean warm water to the fill line.
5. Pour **three teaspoons** of low-foaming dishwasher crystals, (not gel) and **1 ounce** of household bleach for up to six gallons of water.

Follow your state board requirements as they may differ from the above step.

6. Turn on the whirlpool and let run for ten minutes.
7. Turn the whirlpool off and drain water from the basin.
8. Using the sprayer, rinse off all components, surfaces, and basin.
9. Refill the basin with clean water and turn the whirlpool on. Run for one minute to rinse.
10. Drain water from the basin and turn off the whirlpool.
11. Wipe dry with clean towel.
12. Make a record of the date and time of this cleaning and disinfecting.

Once a Week Overnight Cleaning:

In addition to the daily cleaning, the following cleaning procedures must be done every week:

1. Follow steps **one through five** above, as in "After the Last Pedicure of the Day."
2. Turn on the whirlpool and let run for ten minutes.
3. Turn the whirlpool off and let the water sit overnight in the basin (six to ten hours).
4. In the morning, run the whirlpool for five minutes and drain the basin.
5. Rinse the basin with clean water using the sprayer and dry with a clean towel.
6. Make a record of the date and time of this cleaning and disinfecting.

CAUTION: Cleaning products that contain abrasives can damage the pedicure spa. Use ONLY non-abrasive products to clean the pedicure spa.

TRADITIONAL WHIRLPOOL (WITH JETS) - OPERATING INSTRUCTIONS

After the pedicure spa is installed and the plumbing and electrical connections are made, clean and disinfect the basin before initial use. Rinse the basin by using the attached water sprayer. Wipe the basin dry with a clean towel.

To Operate the Pedicure Spa, Follow These Easy Steps:

Adding Water to the Pedicure Spa Basin:

1. Close the drain by turning the chrome drain handle counter-clockwise until it stops.
2. Add water to the basin by lifting upward on the water faucet fill handle. Turn the handle in a counter-clockwise direction for cold water or clockwise for warm water as indicated by the red (hot) and blue (cold) markings around the handle (CAUTION: hot water can burn skin). Continue to add water until the fill line is reached. The fill line is indicated by the wavy (~~~~) line in the basin.
3. Turn the off water by pushing the handle downward and center.

Operating the Water Jets:

Each pedicure spa is equipped with two fully adjustable jets that create a soothing foot massage. To operate, turn the whirlpool jets on by turning the On/Off Switch in a clockwise direction. To increase jet strength, open each jet by simply rotating the adjustment cover in a counter-clockwise direction. To decrease water pressure, close each jet by rotating the adjustment cover in a clockwise direction (**NOTE: The Jet heads should not be positioned directly at the suction cover. Doing so will create a noisy “gurgling” sound as air is being forced directly into water pipes**). Turn off the whirlpool jets by turning the On/Off switch counter-clockwise to its original starting position.



Removing Water from the Pedicure Spa Basin:

First, make certain the whirlpool jets are off by turning the On/Off Switch counter-clockwise to the “Off” position.

If the pedicure spa is hooked up directly to a floor drain, simply open the drain by turning the drain handle in a clockwise direction until it stops. You should see the water level lowering as water exits the basin.

If the pedicure spa is equipped with the optional Power Drain Pump (PDP) feature, open the drain by turning the drain handle in a clockwise direction until it stops, and then press the button marked “Drain” on the front panel. The water level will lower as water is pumped out of the basin. Turn the pump off by pressing the “Drain” button on the front panel once the basin is fully drained. (**NOTE: The Power Drain Pump will automatically shut off after 2-1/2 minutes. We recommend turning off the pump manually if all water has drained before automatic shut-off.**)

Warning:

It is extremely important to follow the cleaning instructions located on the following page. Failure to clean the pedicure spa adequately can result in serious health issues for your clients as well as the nail technician. Failing to clean your pedicure spa may also cause the pedicure spa to not work properly. Always consult your local and state codes concerning pedicure chair cleaning for further requirements.

TRADITIONAL WHIRLPOOL (WITH JETS) - SPA CLEANING AND DISINFECTING

PROCEDURES

Always check with your state board for required cleaning and disinfecting procedures.

It is extremely important to clean and disinfect your pedicure spa **after each pedicure, after the last pedicure of the day, and once a week for overnight cleaning.** Regular cleaning will help keep your pedicure spa in good working condition. Proper and continuous cleaning will kill harmful bacteria and germs that can cause infection.

To clean the pedicure spa, follow these easy steps:

After Each Pedicure:

1. Drain water from the pedicure spa by turning the drain handle to the "Open" position. **Remove all debris.**
2. Clean all the surfaces of the basin and all components. Use low-sudsing soap or detergent, and a non-abrasive brush. Remove all visible residue from basin and then rinse with the sprayer.
3. Disinfect all surfaces and components with an EPA registered disinfectant in accordance with your state board requirements. ***EPA disinfectants require ten-minute contact.**
4. Rinse off with clean water using the sprayer and wipe all parts dry with clean towel.

After Last Pedicure of the Day:

1. Drain water from the pedicure spa by turning the drain handle to the "Open" position. **Remove all debris.**
2. Remove the following:
 - a. Drain cover as shown on page 21.
 - b. Suction cover as shown on page 20.
 - c. Jets as shown on page 20.
3. Remove all debris then wash each component with low-sudsing soap, or detergent, using a soft brush. Disinfect the components as well as the areas behind them with an EPA registered disinfectant. Follow your state board requirements for disinfecting. Replace all components.
4. Clean all the surfaces of the basin using low-sudsing soap or detergent, and a non-abrasive brush. Remove all visible residue from basin and then rinse with sprayer.
5. Fill basin with clean warm water to the fill line.
6. Pour into the basin **three teaspoons** of low-foaming dishwasher crystals (not gel) and **1 ounce** of household bleach for up to six gallons of water.

Follow your state board requirements as they may differ from the above step.

7. Turn on the whirlpool jets and let run for ten minutes.
8. Turn the jets off and drain water from the basin.
9. Rinse the basin and all other components with clean water using the sprayer.
10. Refill the basin with clean water. Turn the jets on and run for one minute.
11. Drain water from the basin and turn off the whirlpool jets. Then wipe dry with a clean towel.
12. Make a record of the date and time of this cleaning and disinfecting.

Once a Week Overnight Cleaning:

In addition to the daily cleaning, the following cleaning procedures must be done every week.

1. Follow steps **one through seven** as listed above as in "After Last Pedicure of the Day."
2. Turn jets off after ten minutes and **let solution sit over night in basin (six to ten hours).**
3. The next morning drain, rinse, and wipe dry with a clean towel.
4. Make a record of the date and time of this cleaning and disinfecting.

CAUTION: Cleaning products that contain abrasives can damage the pedicure spa. Use ONLY non-abrasive products to clean the pedicure spa.

REMOVAL / REPLACING JET PARTS



Tools required:

Pliers

7/8" deep well socket with extension

Check your state and local regulations for cleaning procedures. Links to your state boards can be found on our web site, at www.europeantouch.com. Refer to the cleaning procedure page headed "Traditional Whirlpool (With Jets) - Spa Cleaning and Disinfecting Procedures," page 19, for cleaning recommendations.

Follow the steps below for cleaning and replacing parts:

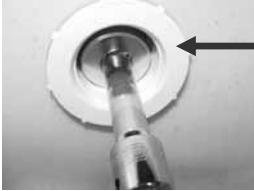
 <p>Step 1: Remove the jet eyeball using the pliers. Pull forward with a quick tug.</p>	 <p>Step 3: Remove the jet nozzle and nut using a 7/8" deep-well socket and extension.</p>
 <p>Step 2: Remove the adjusting cover. This should pull out.</p>	 <p>Step 4: For cleaning, refer to "Traditional Whirlpool (With Jets) - Spa Cleaning and Disinfecting Procedures" on page 19. Reassemble the jet assembly. The jet nozzle nut should be hand tightened using the socket with extension. If the adjustment cover is hard to turn, slightly loosen the jet nozzle nut.</p> <p><i>Clean this area, using low foaming soap and disinfectant, with a brush. Remove all visible residue and rinse with clean water.</i></p>
<p>Step 5: Reverse steps to reassemble.</p>	



REMOVAL / REPLACING SUCTION COVER

Tools required:

Phillips head screwdriver

Check your state and local regulations for cleaning procedures. Links to your state boards can be found on our web site, at www.europeantouch.com. Refer to the cleaning procedure page headed "Traditional Whirlpool (With Jets) - Spa Cleaning and Disinfecting Procedures," page 19, for cleaning recommendations.

Follow the steps below for cleaning and replacing parts:

 <p>Step 1: Unscrew Phillips head screw, located in the center of suction cover, turning counter clockwise.</p>	 <p>Step 2: Pull cover forward to remove.</p> <p><i>Clean this area, using low foaming soap and disinfectant, with a brush. Remove all visible residue and rinse with clean water.</i></p>
<p>Step 3: For cleaning, refer to "Traditional Whirlpool (With Jets) - Spa Cleaning and Disinfecting Procedures" on page 19.</p>	
<p>Step 4: Put cover back on and replace Phillips head screw turning clockwise.</p> <p style="text-align: right;">Caution: Do not over tighten screw.</p>	





REMOVING / REPLACING DRAIN HANDLE

Tools required:

Phillips head screwdriver

Check your state and local regulations for cleaning procedures. Links to your state boards can be found on our web site, at www.europeantouch.com. Refer to the cleaning procedure page headed "Crystal Clean™ Pipe-Free® Spa - Cleaning and Disinfecting Procedures," page 17, and "Traditional Whirlpool (With Jets) - Spa Cleaning and Disinfecting Procedures," page 19, for cleaning recommendations.







Follow the steps below for cleaning and replacing parts:

 <p>Step 1: To remove the chrome handle pull it forward. If difficult to remove, gently pry it off with the screwdriver.</p>	 <p>Step 3: Picture, with the adapter removed, shown for cleaning reference.</p>
 <p>Step 2: To remove the handle adapter, place Phillips head screwdriver into upper slot to reach screw, as shown in picture above. Unscrew and then pull adapter forward.</p>	 <p>Step 4: Picture, with Drain Plunger removed, shown for cleaning reference.</p>

REMOVING / REPLACING IMPELLER

Check your state and local regulations for cleaning procedures. Links to your state boards can be found on our web site, at www.europeantouch.com. Refer to the cleaning procedure page headed "Crystal Clean™ Pipe-Free® Spa - Cleaning and Disinfecting Procedures," page 17, for cleaning recommendations.

Follow the steps below for cleaning and replacing parts:

 <p>Step 1: Remove the Knobs by turning counter clockwise.</p>	 <p>Step 3: Unscrew to remove the impeller knob.</p>	 <p>Step 5: Complete steps 1 through 4 in reverse to replace the parts.</p>
 <p>Step 2: Lift the footplate to remove.</p>	 <p>Step 4: Lift the impeller.</p>	 <p>Step 6: Press firmly down on footplate to help seal while tightening Knobs.</p>



EUROPEAN TOUCH™

**EUROPEAN TOUCH
8301 W. Parkland Court
Milwaukee, WI 53223**

**Phone Number: 414-357-7016
Toll Free: 800-626-6912
Fax: 414-357-6360**

**Web Site: www.europeantouch.com
Email: info@europeantouch.com**