



EUROPEAN TOUCH™

The World's Finest Pedicure Spas

**OWNER'S MANUAL
FORTE SPA
&
ALTERA SPA
CLEAN TOUCH™ PIPE-FREE®**

European Touch - Limited Conditional Warranty

European Touch Holdings, Inc. ("European Touch") conditionally warrants your whirlpool pedicure spa (the "Pedicure Spa") in accordance with the terms and conditions set forth below for a period of one (1) year commencing on the original date of shipment of the Pedicure Spa to you. The warranty only applies to the Pedicure Spa's original end-user owner or customer (the "Customer"). **This Conditional Warranty is non-transferable and replaces any warranties previously published by European Touch.**

If examination of the Pedicure Spa by European Touch during the applicable warranty period shows it to have a defect in material or workmanship, European Touch will, at its option, repair or replace the defective component or part thereof. Further, European Touch may, at its discretion, replace a defective component or part with a refurbished component or part, or may replace the Pedicure Spa with a refurbished pedicure spa. If European Touch elects to replace the Pedicure Spa, the replacement pedicure spa must be comparable in style and size to the Pedicure Spa. The customer shall bear all charges incurred for the shipment to it of a replacement spa or components or parts. This limited warranty also covers the cost of all labor incurred in repairing defects in the Pedicure Spa or repairing or replacing any of its defective components or parts, when the work is done by a **pre-authorized European Touch preferred service provider**; provided, however, that labor is not covered for those parts listed on attached **Exhibit A** as provided below. Cost of repair by any non-authorized service provider is not reimbursable and may void this warranty.

The foregoing limited warranty does not apply:

- To the Pedicure Spa, or any components or parts thereof, if subjected to misuse or neglect or if accidentally or intentionally damaged.
- To the Pedicure Spa, or any components or part, if altered or modified in any way.
- To any expenses incurred by the Customer or any third party, including labor or material, during investigation, removal or reinstallation of the Pedicure Spa or any defective components or parts.
- To any damage to or impairment of the Pedicure Spa, or any components or parts thereof, caused by any casualty, including without limitation, accident, fire, wind, floods, acts of nature or attempted theft.
- To any workmanship of a fabricator (other than European Touch) or installer of the Pedicure Spa.
- If damage to pump parts and/or motor parts is due to obstructed plumbing.
- If the Pedicure Spa is removed from its place of initial installation.
- To staining, fading, or discoloration of any portion of the Pedicure Spa caused by water additives or improper water treatment.
- To staining, fading or discoloration of the Pedicure Spa's upholstered seat, armrests or footrests.
- To malfunctions or damage caused by improper installation of the Pedicure Spa, including, but not limited to, failure to meet state or local plumbing, electrical and building codes and other applicable laws and regulations.
- To damage resulting from a person standing in the Pedicure Spa's basin or other similar stress to that basin.
- To freight damage.
- To damage incurred to the Pedicure Spa while in possession of any party other than European Touch.

- To any special costs imposed by any landlord or other party controlling the building in which the Pedicure Spa is located such as the cost of fidelity bonding or unique licensing requirements, all of which costs shall be borne by the Customer.
- To any labor costs to install those parts listed on attached **Exhibit A** which consist of items which do not require the skills of a trained technician to install.

This forgoing conditional limited warranty is also conditional upon:

- The Pedicure Spa being installed by a licensed professional in accordance with European Touch's installation instructions and applicable state and local plumbing, electrical and building codes and other applicable laws and regulations.
- Use of the Pedicure Spa in compliance with all regulatory and industry guidelines (including without limitation, UL and NSF guidelines and applicable state and local plumbing, electrical and building codes and other applicable laws and regulations)
- Use of parts and components which are either genuine European Touch parts and components or are parts and components approved for use by European Touch. Failure to comply with this requirement may also lead to voiding of the Pedicure Spa's UL and NSF approvals and applicable state and local plumbing and other certifications which could impact compliance with state and local codes and regulations as well as insurance coverage requirements.
- The proper use of cleaning and sanitizing solutions in accordance with the instruction labels provided by European Touch or the requirements of applicable law. Repeated use of concentrated chlorine or other chemicals will void this limited warranty, except to the extent such use is required by the provisions applicable law.
- Avoidance of the use of ionic detox machines that submit any metallic part to reverse electroplating; this use will destroy plated parts and void the warranty.
- Shipment, if requested, to European Touch of Pedicure Spa parts or components thought to be defective. Parts or components may only be returned if authorized in advance by European Touch. All returns must be freight prepaid.
- Determination by European Touch, in its reasonable discretion, that there exists a defect in material or workmanship.

Repair or replacement of any part or component under this Limited Warranty, or furnishing a replacement pedicure spa, shall not extend the duration of the warranty with respect to such repaired or replaced part beyond the stated warranty period. When a part or component is replaced, it will be under warranty for 90 days, or for the remaining life of original warranty, whichever period is greater.

Customer agrees by using the Pedicure Spa that

- **THE OBLIGATION OF EUROPEAN TOUCH SHALL NOT EXTEND TO INDIRECT OR CONSEQUENTIAL DAMAGES OR INJURY WHICH MAY RESULT FROM SUCH USE**
- That the obligations of European Touch are limited to those set forth herein.
- This warranty is limited to the original owner/end-user and is non-transferable.
- European Touch shall not be liable for any other obligations or liabilities, including, but not limited to: obligations or liabilities arising out of breach of contract or warranty, negligence, or other tort or any theory of strict liability with respect to the Pedicure Spa or parts or components thereof or any acts or omissions of European Touch
- Any assistance European Touch provides to the Customer outside of terms, limitations, or exclusions of this limited warranty will not constitute a waiver of any of the foregoing terms, limitations, or exclusions, nor will such assistance extend or revive the warranty.

THIS LIMITED WARRANTY IS IN LIEU OF ALL OTHER WARRANTIES, EITHER EXPRESS OR IMPLIED, AND ALL SUCH OTHER WARRANTIES, INCLUDING WITHOUT LIMITATION, IMPLIED WARRANTIES OF MERCHANTABILITY OR FITNESS FOR A PARTICULAR PURPOSE, ARE HEREBY DISCLAIMED AND EXCLUDED FROM THIS LIMITED WARRANTY. NO DEALER OR OTHER PERSON HAS ANY AUTHORITY TO BIND EUROPEAN TOUCH TO CHANGES OR ADDITIONS TO THIS WARRANTY. ACCORDINGLY, EUROPEAN TOUCH IS NOT RESPONSIBLE FOR ANY SUCH CHANGES OR ADDITIONS.

IN NO EVENT SHALL EUROPEAN TOUCH BE LIABLE IN ANY WAY FOR ANY CONSEQUENTIAL, SPECIAL, OR INCIDENTAL DAMAGES OF ANY NATURE WHATSOEVER, OR FOR ANY AMOUNTS IN EXCESS OF THE SELLING PRICE OF THE PEDICURE SPA OR ANY COMPONENTS OR PARTS THEREOF FOUND TO BE DEFECTIVE. THIS LIMITED WARRANTY GIVES THE CUSTOMER SPECIFIC LEGAL RIGHTS. THE CUSTOMER MAY ALSO HAVE OTHER RIGHTS WHICH MAY VARY BY EACH JURISDICTION.

Should your Pedicure Spa require service due to a defect or malfunction, please contact:
 European Touch – Technical Support
 800.626.6912 | 414.357.7016 | f: 414.357.6360
 email: service@europeantouch.com
 website: europeantouch.com

Exhibit A for Altera and Forte Clean Touch Extended Service Contract And Limited Warranty Document
Parts for which Labor/Service is NOT COVERED.
The following spa components are simple to replace and do not require a service technician. Therefore, though the part is covered under the guidelines of the warranty agreement, payment to a service technician for labor is not.

Altera and Forte Clean Touch
Body Panels
Clean Touch Impeller
Clean Touch Impeller Cover
Clean Touch Impeller Housing
Clean Touch Sensors
Cushion & Arm pads
Faucet Cartridge
Leveling feet
On/Off / Drain button
PDP pump
Remotes
Sprayer
Water and drain hoses



Certificate of Compliance

For

European Touch

8301 W. Parkland Court
Milwaukee, WI
U.S.A. 53223

For Compliance of:

Equipment: Whirlpool Pedicure Spa
Model No.: SOLACE – PF & SOLACE – PF PDP
Rated: 220-240VAC, 50Hz, 7.5A

To the following standard(s):

EN60335-1:2002
EN60335-2-32:2002
EN 55014-1 (Generic): 2001
EN 55014-2 (Generic): 2003
EN61000-4-2 (Criteria C): 2001
EN61000-4-3:2002
EN61000-4-4: 1995
EN61000-4-5: 2001
EN61000-4-6: 2001
EN61000-4-11: 2004

Project No.: 8311-1
Issue Date: December 30, 2005

Issued by:

Kavinder Dhillon
President

ONE STOP GLOBAL CERTIFICATION SOLUTIONS





EUROPEAN TOUCH™
OWNERS MANUAL For
Whirlpool Pedicure Spa Models:
FORTE AND ALTERA
IMPORTANT INFORMATION

Serial Number: _____

Work Order Number: _____

Installed by: _____

Installation Date: _____

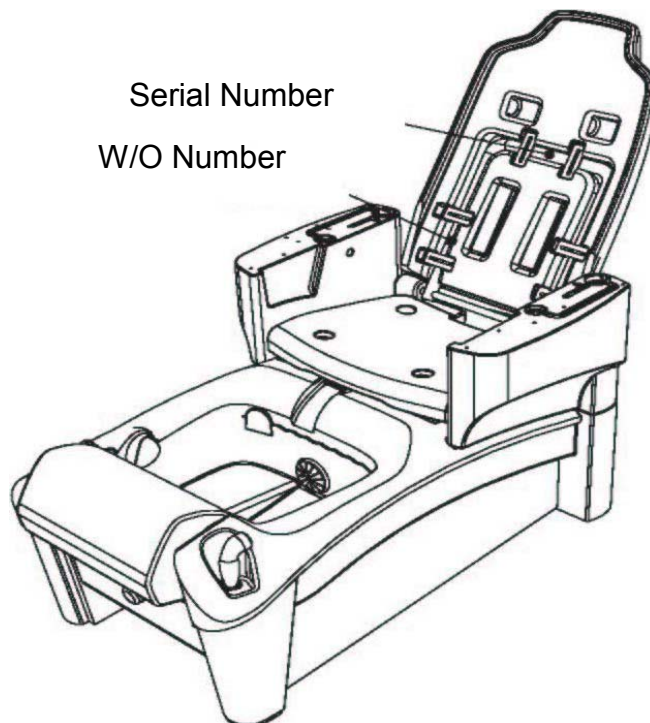

Note: Vietnamese and Korean translations available upon request.



EUROPEAN TOUCH™

TABLE OF CONTENTS

European Touch - Limited Conditional Warranty.....	2
Certificate of Compliance.....	5
IMPORTANT INFORMATION.....	6
INTRODUCTION.....	8
IMPORTANT REQUIREMENTS.....	8
DANGER.....	9
WARNINGS.....	9
INSTALLATION SPECIFICATIONS SUMMARY.....	10
IMPORTANT INSTALLATION AND UTILITY INFORMATION.....	11
DIMENSIONAL DRAWINGS.....	12
SPECIFICATIONS.....	13
SPECIFICATIONS.....	14
ATTACHING THE SEAT BACK.....	15
UNPACKING THE CUSHIONS.....	16
REMOTE CONTROL CONFIGURATIONS.....	16
ATTACHING THE CUSHIONS.....	17
COMPONENT REFERENCE.....	18
PEDICURE PRODUCT GUIDELINES.....	18
REMOVING AND REPLACING DRAIN STRAINER.....	18
CLEAN TOUCH™ PIPE-FREE® SPA - OPERATING INSTRUCTIONS.....	19
CLEAN TOUCH™ PIPE-FREE® SPA CLEANING AND DISINFECTING PROCEDURES.....	20
REMOVING / REPLACING DRAIN HANDLE.....	21
REMOVING / REPLACING IMPELLER.....	21
HISTORY AND NOTES.....	22



EUROPEAN TOUCH™

INTRODUCTION

Thank you for selecting EUROPEAN TOUCH, the leading designer, manufacturer, and marketer of pedicure spas in North America. The Forte and Altera pedicure spas (herein referred to as pedicure spa) are innovative whirlpool pedicure spas that have been designed to serve you dependably for many years. Please take time to thoroughly read this entire manual before installation and use. If you have any problems or have questions regarding your pedicure spa, please contact EUROPEAN TOUCH's Technical Support Department at **1-800-626-6912**, Monday through Friday 8 AM to 6:30 PM CST. After hours calls are recorded and attended to the next business day.

IMPORTANT REQUIREMENTS

EUROPEAN TOUCH requires that you contact a local, licensed plumber and licensed electrician to install your new pedicure spa. Installation must be in compliance with all your local and state building codes. Your pedicure spa cannot operate efficiently or safely unless it is provided with adequate electrical power, sufficient water pressure, proper water temperature, and required drainage capabilities. Contact your local building inspector for information and local code compliance procedures that need to be followed when having your pedicure spa installed. Subsequent inspections and approvals that may be required are the responsibility of the purchaser. **(See limited warranty regarding incidental or consequential exclusions – page 2).**

PRECAUTIONS

- Do not stand in the basin of the pedicure spa!
- Excessive water temperature is dangerous and should be checked before use. Maximum operating water temperature should not exceed 105° F (41° C) and the maximum supply water temperature should not exceed 120°F (49° C).
- Always enter and exit the pedicure spa slowly and carefully.
- Close side arms rests before operating the chair seat movement.
- Never bring or operate any electrical devices into or near the pedicure spa.
- This pedicure spa has a weight capacity of 250 pounds (113.4kg).

HEALTH RISK WARNING

Individuals whose feet or legs are inflamed or have open wounds should not be allowed to use the pedicure spa at any time. Nail technicians should advise clients to consult their physician before using the pedicure spa if there is any sign of fungal infection, swelling, fracture, or persistent pain. In some cases diabetics may experience improved circulation in their feet, but should first consult their physician prior to receiving a pedicure. **If the client experiences any pain or discomfort, immediately discontinue the use of the pedicure spa.**

Your client's massage and pedicure spa experience should be pleasant and comfortable.



EUROPEAN TOUCH™

DANGER

- 1) Never use pins or other metallic fasteners with this appliance.
- 2) Carefully examine the covering before each use.
- 3) Discard the appliance if the covering shows any sign of deterioration, such as checking, blistering, or cracking.
- 4) Keep Dry – Do not operate in a wet or moist condition.

WARNINGS

- 1) WARNING: RISK OF ELECTRIC SHOCK; do not permit electric appliances (such as a hair dryer, lamp, telephone, radio, or television) within 1.5M of this hydromassage basin.
- 2) CAUTION: Test the ground fault circuit interrupter protecting this appliance periodically in accordance with the manufacturer's instructions.
- 3) Temperatures sufficiently high to cause burns may occur regardless of the control setting.
 - a. Do not use on...
 - Infants
 - Invalids
 - Sleeping or unconscious persons.
 - b. Do not use on...
 - Sensitive skin
 - Person with poor blood circulation.

Note: Check the skin in contact with the heated area of the appliance frequently to reduce the risk of blistering.

- 4) Excessive water temperature is dangerous and should be checked before use. Maximum operating water temperature should not exceed 105° F (41° C) and the maximum supply water temperature should not exceed 120°F (49° C).
- 5) The spa could have a heated surface in the seat back cushion. Persons sensitive to heat must be careful when using the spa.
- 6) Always enter and exit the pedicure spa slowly and carefully.
- 7) **Close side arm rests before operating the chair seat movement.**
- 8) Never bring or operate any electrical devices into or near the pedicure spa.
- 9) This pedicure spa has a weight capacity of **250** pounds.
- 10) Do Not Crush – Avoid sharp folds
- 11) Do not stand on or in appliance.
- 12) Use only while seated.
- 13) Keep children away from extended foot support
- 14) Connect this appliance to a properly grounded outlet only. See Grounding Instructions within the install manual.

Note: Always verify maximum temperatures with your local & state codes.

INSTALLATION SPECIFICATIONS SUMMARY

Note: Failure to comply with federal, state or local codes and ordinances will result in the warranty being null and void.

As stated, the pedicure spa installation must comply with all plumbing and electrical codes. A licensed plumber and licensed electrician must complete the applicable connections of the pedicure spa.

LOCATION AND SUPPORT

Select a level location. The floor structure beneath the pedicure spa must be capable of supporting the occupied pedicure spa.

For the seat back to fully recline, the pedicure spa base must be mounted a minimum distance from the wall:

Forte model	18" (46 cm)] = "X" dimension, below, by model.
Altera model	12" (31 cm)	

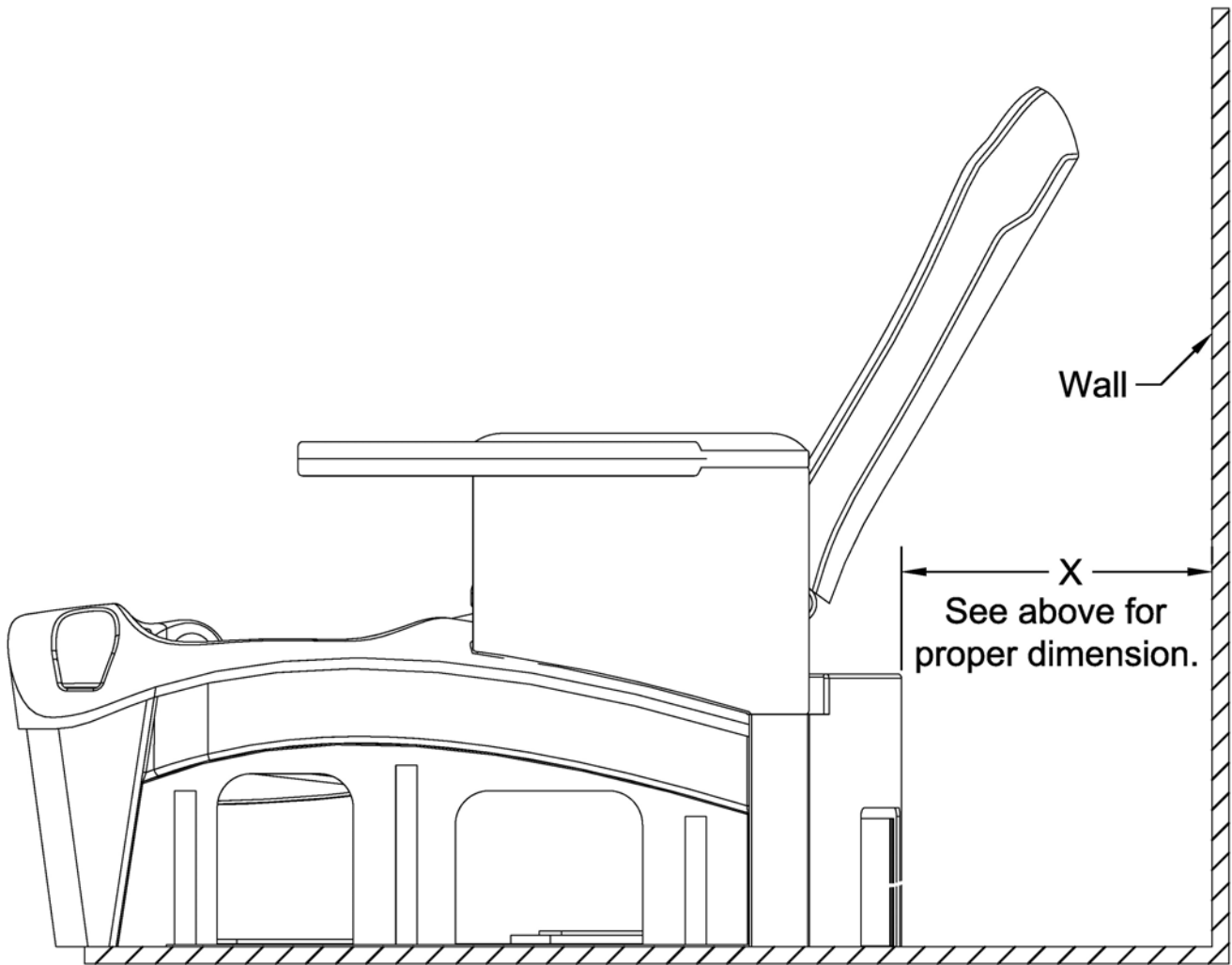

IMPORTANT INSTALLATION AND UTILITY INFORMATION

Electrical Service:

- 110V: A 110V, 60 Hz, 15 Amp GFCI protected grounded circuit must be used to supply power to the pedicure spa. (220V if ordered in 220V configuration)
- 220V: A 220-240VAC, 50Hz, 7.5 Amp GFCI protected grounded circuit must be used to supply power to the pedicure spa per local code.

Water Supply:

All plumbing connections must conform to local codes. Normal water pressure of 30 to 80 PSI is required to correctly fill the basin to the proper level. The hot water supply temperature must not exceed 120°F (49° C). Adjust your hot water heater accordingly. For hot and cold water supply fittings and power drain fittings location, see figure 1 below. Carefully connect the incoming water supply lines to the appropriate fittings located on the back of the pedicure spa. Shut-off valves are recommended.

Backflow Protection Devices for Faucets with Side Spray: Check valves comply with ANSI/ASME A112.18.3M, A112.18.1M, and CSA B125

ANSI/ASME A112.18.3M (Performance Requirements for Backflow Protection Devices and Systems in Plumbing Fixture Fittings) is applicable to plumbing fixture fittings with outlets not protected by an air gap. Included in the possible range of applications are fittings with hose connected outlets, fittings with pullout spout, hand held showers, shampoo fittings and deck-mounted fittings. ASME A112.18.3M is now referenced in ASME A112.18.1M (Plumbing Fixture Fittings) and CSA B125. Check valves are listed to both standards with the Canadian Standards Association, IAPMO and UL.

- ANSI** - American National Standards Institute
- ASME** - American Society of Mechanical Engineers
- CSA** - Canadian Standards Association
- IAPMO** - International Association of Plumbing and Mechanical Officials
- UL** - Underwriters Laboratory

The pedicure spa drain must meet local plumbing codes. **Check valve for drain (not provided) must be installed by a licensed plumber.**

Pedicure spa must be securely fastened to the floor as shown in figure 2 below. Fasten the pedicure spa to the floor with at least two fasteners, one in the middle plastic support and one in the rear plastic support.

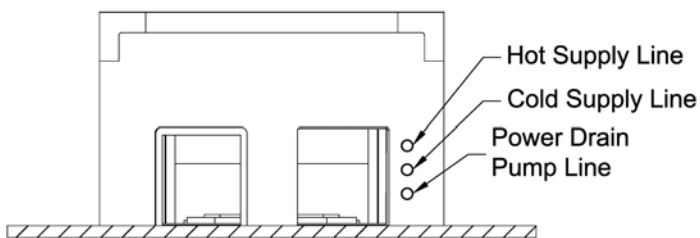

Back of Pedicure Spa
Figure 1

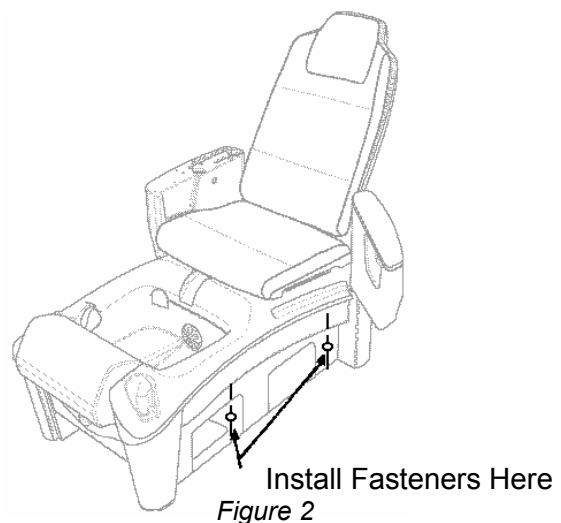

Figure 2

DIMENSIONAL DRAWINGS

CLEAN TOUCH™ PIPE-FREE®

"X" dimension - by model

Forte model.....18" (46 cm)
 Altera model.....12" (31 cm)

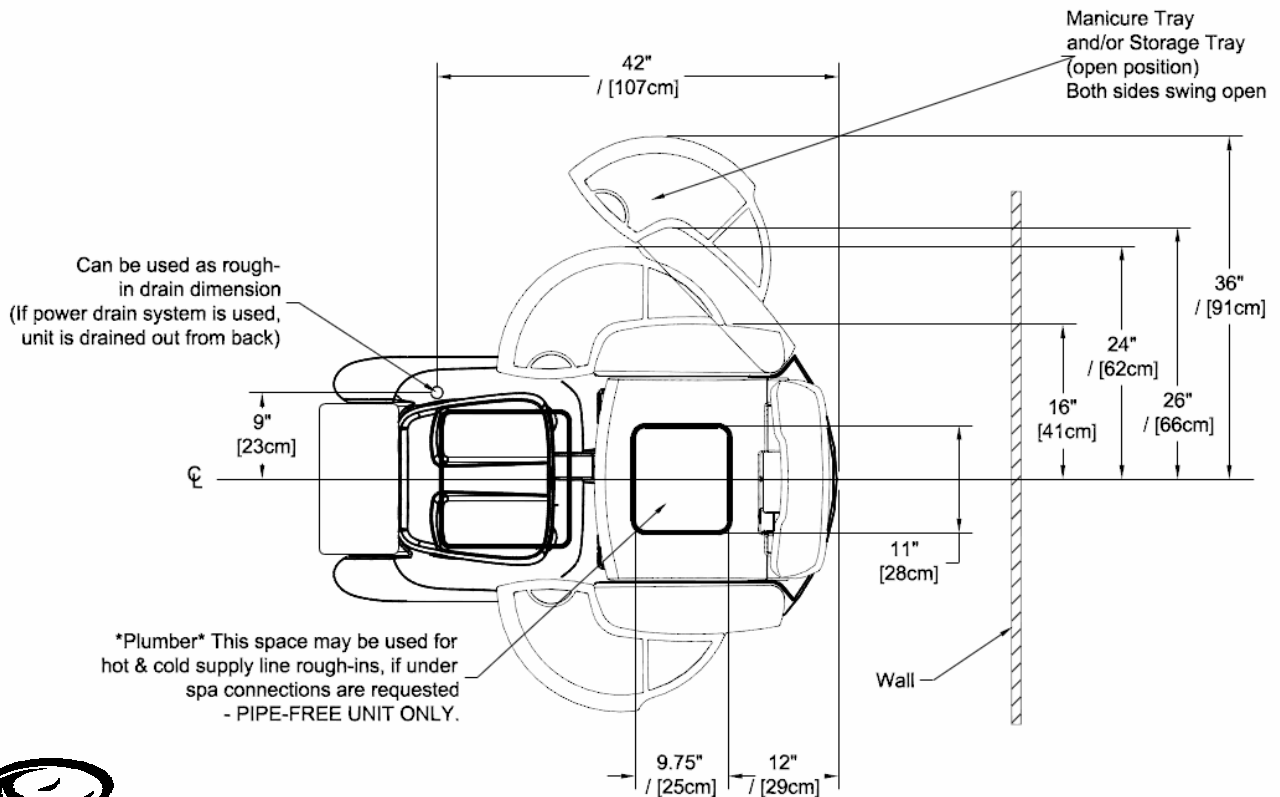
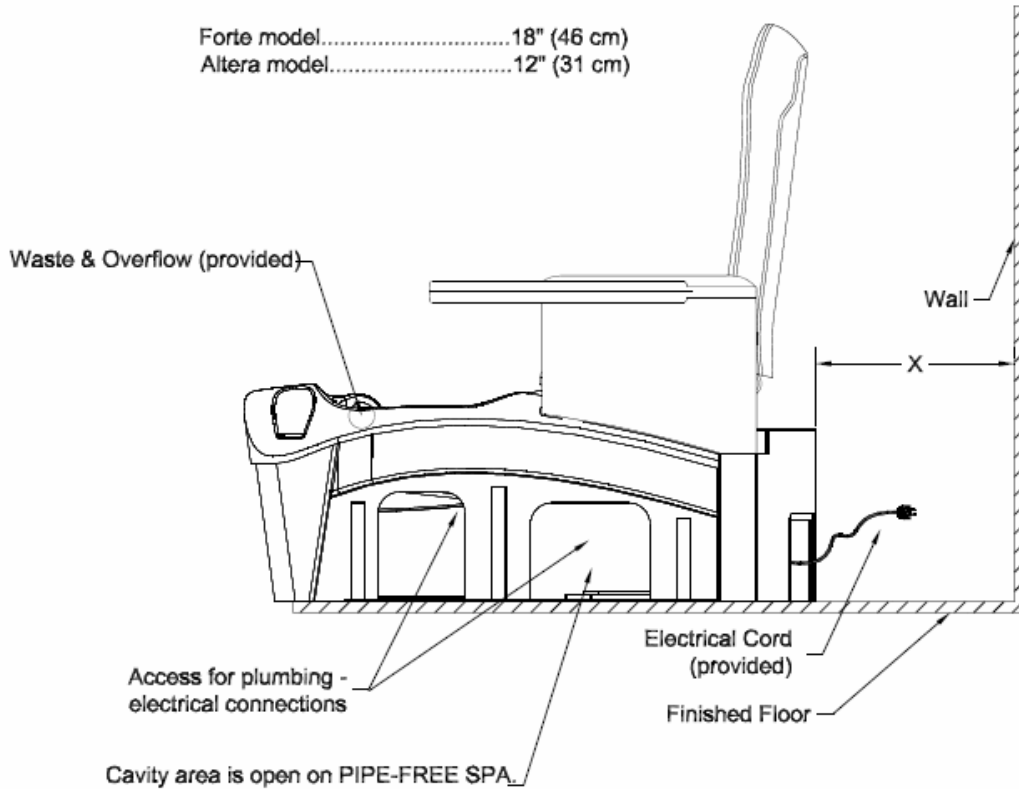

CLEAN TOUCH™ PIPE-FREE®

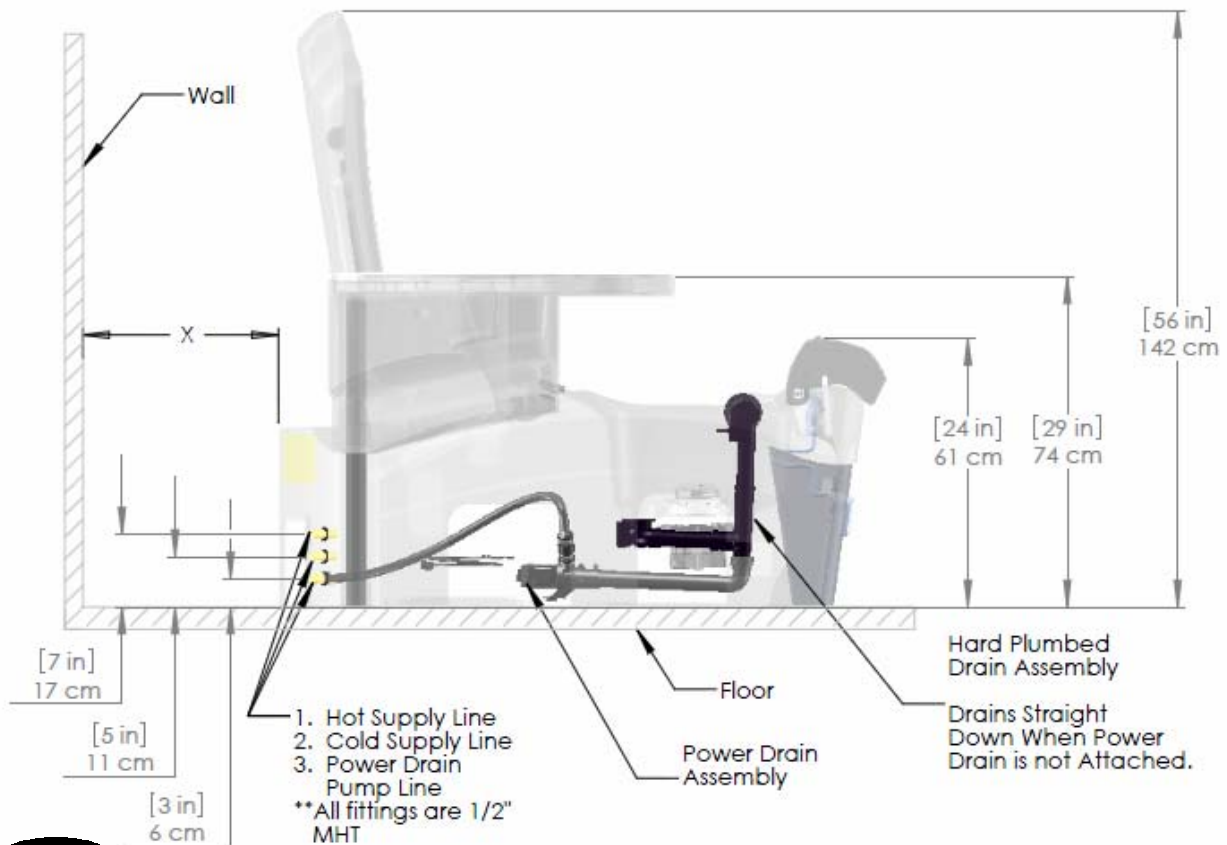
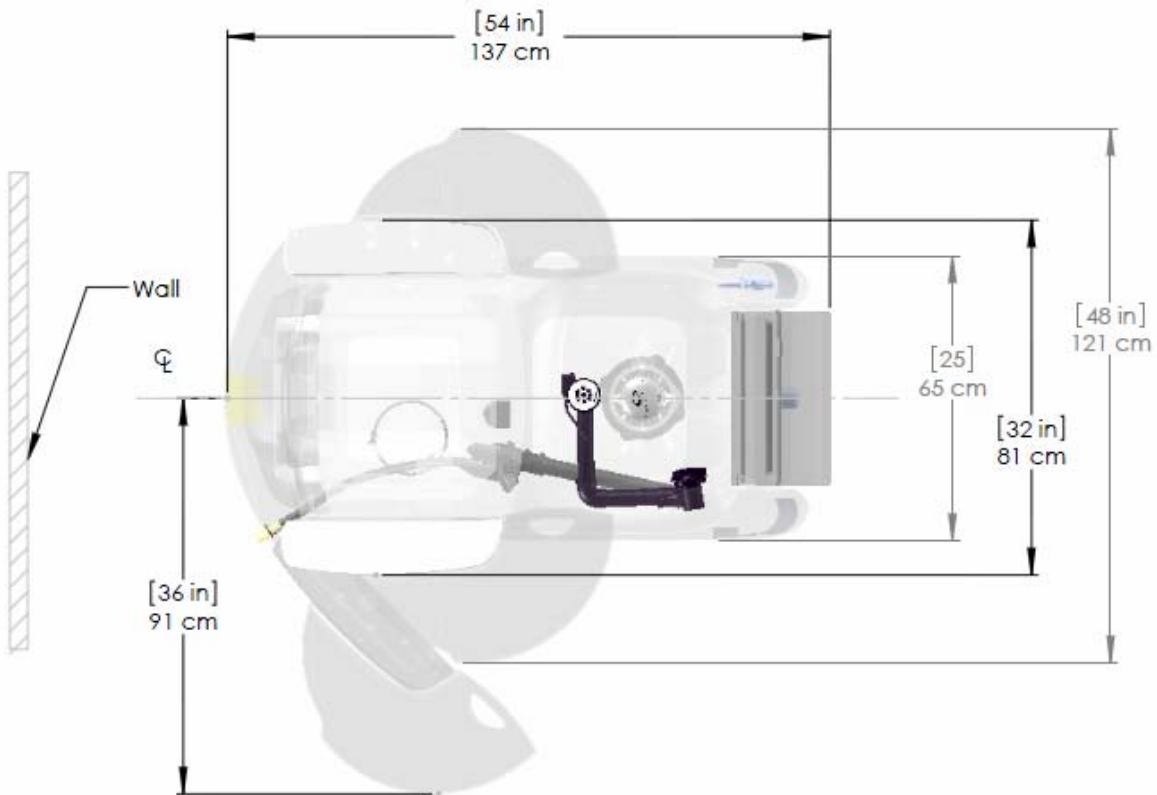

SPECIFICATIONS

Hot and cold water supply lines required (hot and cold shut off valves may be installed under pedicure spa base)
See pages nine through eleven.

Drain installation: References noted on pages nine through eleven, can be installed with optional power drain pump or as gravity drain.

Overall dimensions without accessories, seat upright: 54" (138cm) L x 32" (79cm) W x 56" (143cm) H*

Without accessories, seat collapsed: (shipping position): 54" (138cm) L x 32" (82cm) W x 36" (92cm) H*

Shipping dimensions: 55" (140cm) L x 33" (84cm) W x 41" (105cm) H*

Empty weight: 150 lbs (68kg)*

Shipping weight: 205 lbs (93kg)*

Capacity of basin: 5.75 U.S. Gallons (21.8L) = Clean Touch™ Pipe-Free®*

Whirlpool pump motor: **110V:** 1/6 HP, 110V, 60HZ (alternate voltages available) (3/4 HP for Traditional Whirlpool - *with Jets*)

220V: 1/6 HP, 110V, 50Hz (alternate voltages available) (3/4 HP for Traditional Whirlpool - *with Jets*)

Forte seat and back motors: 30V DC Linear Actuators. Forte requires 18" (46 cm) of space between pedicure spa and wall with standard actuator.*

Altera seat and back movement: 2 infinitely adjustable lockable gas cylinders for reclining/sliding. The Altera requires 12" (31cm) of space between pedicure spa and wall in order for seat to recline to its fullest extent.*

Massage motor: 12V AC, Adapter included (alternate voltages available)

Power source: **110V:** 110V AC / 15 Amp, 60 Hz (GFCI Protected)

220V: 220-240VAC, 50Hz, 7.5 Amp (GFCI Protected)

Caution: Pedicure spa must be installed by a licensed electrician and a licensed plumber, conforming to all local and national electrical codes.

Construction: Linear Low Density Polyethylene (LLDPE), self-contained, pre-plumbed

Clean Touch™ Pipe-Free® Technology with four water massage channels. No closed loop circulating pipes, fully drained.

Electrical switches: On/Off switch for whirlpool pump. Hand-held low voltage remote controls for massage motors, heat, and seat/back position. Hot and Cold water supply lines required.

UL listed/CE certified: Complies with ASME/ANSI Whirlpool Basin Specs ASME/ANSI A112.19 7M-1995 and A112.19.8M-1995. Backflow Protection Devices for Faucets with Side Spray: Check valves comply with ANSI/ASME A112.18.3M, A112.18.1M, and CSA B125.

Performance Limits:

1. This unit may lose one or more functions when electrostatic contact discharge in excess of 4KV gets into accessible conductive part of the unit and could be restored by resetting the unit.
2. This unit may lose one or more functions when power surge in excess of 2KV is applied to the AC input power port and could be restored by resetting the unit.
3. This unit may lose one or more functions when subjected to fast transient voltages in excess of 0.5KV at 5 KHz repetition frequency and could be restored.







Limited warranty: One (1) year from date of purchase.

Due to our policy of continuous improvements, all specifications are subject to change without notice.

**Note: All dimensions and weights are approximate*

ATTACHING THE SEAT BACK

Your pedicure spa shipped with the seat bottom and seat back already attached to the base. Follow these instructions to connect the seat back to the pedicure spa:

<u>Forte</u>	<u>Altera</u>
 <p>Step 1: Remove the hitch and clevis pins located on the seat back mounting bracket on the back of the chair.</p>	 <p>Step 1: Remove the hitch and clevis pins located on the seat back mounting bracket on the back of the chair.</p>
 <p>Step 2: Slide the seat bracket into the black end on the linear actuator, and line up the holes.</p>	 <p>Step 2: Line up the hole on the seat bracket with the hole on the cylinder end.</p>
 <p>Step 3: Slide the clevis pin through the holes and secure by inserting the hitch pin through the small hole on the clevis pin.</p>	 <p>Step 3: Slide the clevis pin through the holes and secure by inserting the hitch pin through the end hole on the clevis pin.</p>





UNPACKING THE CUSHIONS

Your cushion set is packaged in its own box within the pedicure spa shipping carton. All needed parts are located inside of this box. These include:

- (1) Seat Back
- (1) Seat Bottom
- (2) Arm Cushions
 - **Altera Vibration Massage Only:** The remote and junction box

Please make sure that all parts are removed from the box before discarding the box. If any parts are missing, the customer must contact EUROPEAN TOUCH within 30 days of the delivery date for replacement at 800-626-6912.

REMOTE CONTROL CONFIGURATIONS

<p style="text-align: center;">Forte Seat Movement</p>  <p>Recline Seat Back: Tilt Backward or Forward</p> <p>Move Seat Bottom: Slide Forward or Backward</p>	<p style="text-align: center;">Forte/Altera Roller</p>  <p>Indicates that Vibrate Feature is Activated</p> <p>Type of Vibrating Massage: (Surge, Steady, Pulse, Wave)</p> <p>Increase or Decrease Intensity of vibrating massage</p> <p>Timer (15 min or 30 min)</p> <p>Indicates that Roller Feature is Activated</p> <p>Area of Vibration: Zone 1 = Upper Zone 2 = Lower</p> <p>Increase or Decrease Speed of vibrating massage.</p>
<p style="text-align: center;">Forte Vibration</p>  <p>Moves through types of vibration</p> <p>Determines active vibration zone</p> <p>Turn power on/off</p> <p>Increase Speed</p> <p>Decrease Speed</p> <p>Display: Which features are active: current speed, heat, and intensity</p> <p>Use to set timer for the active time</p> <p>Set Heat Level</p> <p>Increase Intensity</p> <p>Decrease Intensity</p>	<p style="text-align: center;">Altera Vibration</p>  <p>LED Shows Massage Zone Activated</p> <p>Activates Massage Zone 1</p> <p>When both switches are centered on "Off" the Massage power is off</p> <p>LED Shows Massage Zone Activated</p> <p>Activates Massage Zone 2</p>

ATTACHING THE CUSHIONS

All pedicure spa cushions attach to the pedicure spa with Velcro. The Forte and Altera Pedicure spas have cables for the cushions that need to be routed properly. Follow these instructions for attaching the cushions properly to your pedicure spa:



Step 1: Your pedicure spa will come with the Velcro already in place for the seat bottom and the seat back.



Step 4: Remove the protective film from the Velcro on the bottom of the arm pads. Carefully place the arm pads on the chair arms and slide the remotes under the remote holders on the arm pads.



Step 7: ALTERA VIBRATION ONLY – The Altera cushion remote control comes attached to the junction box.



Step 2: Attach the seat bottom to the chair bottom. Make sure that the cushion is centered on the chair bottom. The arms should be able to close without cushion interference.



Step 5: FORTE ONLY – The remote control and power supply cord are taped together behind the chair. Remove the tape and connect the cords from the cushion to these connectors.



Step 8: ALTERA VIBRATION ONLY – The Altera junction box should be mounted on the back of the seat back. Plug the 2 cushion cords into the red and white receptacles (they can go into either receptacle). The power supply cord plugs into the receptacle next to the remote cord. Plug the power supply into the power strip.



Step 3: Route the seat back cushion cables underneath the chair back and out the back. Center the seatback cushion on the chair back.



Step 6: FORTE ONLY – Route the seat back cables through the hole in the pedicure spa base.



Step 9: The remotes can be slipped into the armrests as shown.
Note: Close side arms rests before operating the chair seat movement.

COMPONENT REFERENCE

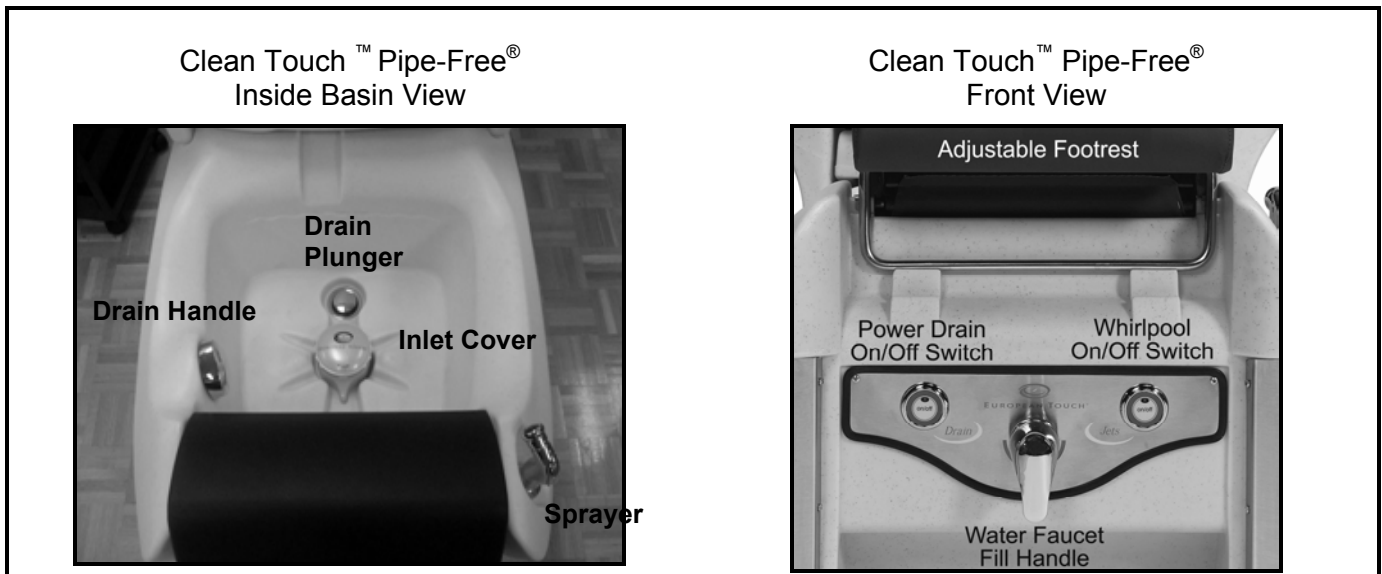

PEDICURE PRODUCT GUIDELINES

Because there are so many different products on the market, it is difficult for us to list all of the pedicure products that are safe to use in our pedicure spas. However, the following guidelines can be used:

- It is your responsibility to understand and follow your state's regulations regarding product usage and disinfecting requirements.
- Do not use any products containing a foaming agent; this will cause excessive foam.
- It has been determined that products containing non-dissolving abrasives (such as sand and sea salts) will not harm the internal component structure of your pedicure spa as long as the entire EUROPEAN TOUCH cleaning requirements are followed without deviation.
- Oil based products may be used in your pedicure spa as long as the cleaning requirements are met.
- Always use pedicure products and cleaning solutions in accordance with each manufacturer's directions.

EUROPEAN TOUCH whirlpool pedicure spas will give you many years of service as long as proper precautions, precise cleaning, and operating instructions are followed. It is the responsibility of the pedicure spa owner to properly clean and maintain the pedicure spa.

If you are experiencing problems cleaning your pedicure spa, please contact EUROPEAN TOUCH Technical Support at 800-626-6912.

REMOVING AND REPLACING DRAIN STRAINER

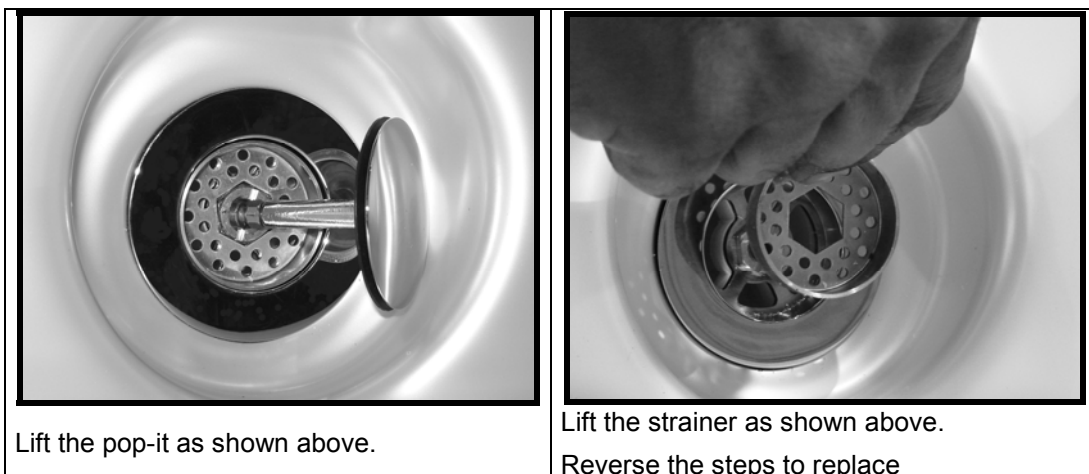

CLEAN TOUCH™ PIPE-FREE® SPA - OPERATING INSTRUCTIONS

Preparing the Pedicure Spa for Operation:

After the pedicure spa is installed and the plumbing and electrical connections are made, clean and disinfect the basin before initial use. Rinse the basin by using the attached water sprayer. Wipe the basin dry with a clean towel.

To Operate the Pedicure Spa, Follow These Easy Steps:

Adding Water to the Pedicure Spa Basin:

1. Close the drain by turning the chrome drain handle counter-clockwise until it stops.
2. Add water to the basin by lifting upward on the water faucet fill handle. Turn the handle in a counter-clockwise direction for cold water or clockwise for warm water as indicated by the red (hot) and blue (cold) markings around the handle (CAUTION: hot water can burn skin). Continue to add water until the fill line is reached. The fill line is indicated by the wavy (~~~~) line in the basin.
3. Turn the water off by pushing the handle downward and to the center.

Operating the Clean Touch™ Pipe-Free® System:

The Clean Touch™ Pipe-Free® System eliminates pipes and jets that can harbor harmful bacteria while at the same time delivering a soothing, quality foot massage. This unique system is driven by an impeller that pulls water through the inlet cover and then forces the water outward. The end result is a soothing massage delivered to all areas of the foot: front, back and bottom.

To start or stop the whirlpool, depress the On/Off button labeled “Jets” (**NOTE: An indicator light on the “Jets” button flashes when the footplate is improperly installed, or the basin contains no water. As a result, the whirlpool will not function. To fix, simply check that the footplate is securely fastened or add water to the basin.**)

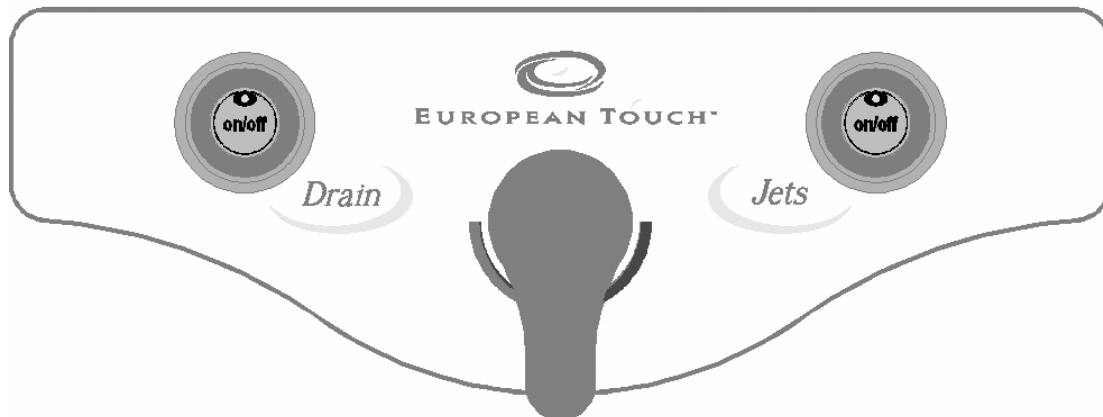

Removing Water from the Pedicure Spa Basin:

First, make certain the whirlpool jets are turned off by turning the On/Off switch counter-clockwise to the “Off” position.

If the pedicure spa is hooked up directly to a floor drain, simply open the drain by turning the drain handle in a clockwise direction until it stops. You should see the water level lowering as water exits the basin.

If the pedicure spa is equipped with the optional Power Drain Pump (PDP) feature, open the drain by turning the drain handle in a clockwise direction until it stops. Press the button marked “Drain” on the front panel. The water level will lower as water is pumped out of the basin. Turn the pump off by pressing the “Drain” button on the front panel once the basin is fully drained (**NOTE: the PDP will automatically shut off after 2-1/2 minutes. We recommend turning off the pump manually if all water has drained before automatic shut-off. Drain pump may overheat if operated more than 10 minutes in a 45 minute period.**)

Warning:

It is extremely important to follow the cleaning instructions located on the following page. Failure to clean the pedicure spa adequately can result in serious health issues for your clients as well as the nail technician. Failing to clean your pedicure spa may also cause the pedicure spa to not work properly. Always consult your local and state codes concerning pedicure chair cleaning for further requirements.

CLEAN TOUCH™ PIPE-FREE® SPA CLEANING AND DISINFECTING PROCEDURES

Always check with your state board for required cleaning and disinfecting procedures.

It is extremely important to clean and disinfect your pedicure spa after each pedicure, after the last pedicure of the day, and once a week for overnight cleaning. Regular cleaning will help keep your pedicure spa in good working condition. Proper and continuous cleaning will kill harmful bacteria and germs that can cause infection. To clean your pedicure spa equipped with Clean Touch™ technology, follow these easy steps.

Procedures for Cleaning and Disinfecting Pipe-Free® Pedicure spas

After use upon each patron, each Pipe-Free Pedicure spa shall be cleaned and disinfected in the following sequential manner:

- (1) All water shall be drained from the spa basin.
- (2) Remove 2 piece inlet housing & impeller.
- (3) Scrub all visible residue from the inlet housing, impeller, inside walls of the basin, and/or other components and the areas behind or under each with a clean brush and liquid soap (labeled as such on soap product) and water. Rinse with clean water.
- (4) Re-insert the properly cleaned inlet housing & impeller,
- (5) Refill the basin with clean water and circulate the correct amount (read the label for mixing instructions) of the EPA-registered hospital-liquid disinfectant which the label claims is a bactericide, fungicide, and virucide, through the basin for at least 10 minutes.
- (6) Drain, rinse and wipe the basin dry with a clean paper towel.
- (7) Record this procedure in the pedicure-cleaning log. The log shall contain the date and time of each cleaning, initials of the person who completed the procedure, and shall indicate that the cleaning was done after a client.

At the end of every day and after performing the procedures provided in subsection (b) (1 through 6) and after the last client, each pipe-free® pedicure spa shall be cleaned and disinfected in the following sequential manner:

- (1) Fill the basin with warm water and detergent (labeled as such on detergent product) and circulate the detergent through the spa system for at least 10 minutes.
- (2) Drain the detergent solution and rinse the basin.
- (3) Refill the basin with clean water and circulate the correct amount (read the label for mixing instructions) of the EPA-registered hospital-liquid disinfectant which the label claims is a bactericide, fungicide, and virucide, through the basin for at least 10 minutes.
- (4) Drain, rinse and wipe the basin dry with a clean paper towel.
- (5) Allow the basin to dry completely.
- (6) Record this procedure in the pedicure-cleaning log. The log shall contain the date and time of each cleaning, initials of the person who completed the procedure, and shall indicate that the cleaning was done at the end of the day.

At least once each week, after completing the procedures provided in subsection (c) (1 through 3), and the disinfectant solution in each pipe-free® pedicure spa shall not be drained and the following sequential procedures shall be followed:

- (1) The unit shall be turned off and the disinfecting solution shall be left in the unit undisturbed for 6 to 10 hours.
- (2) After the disinfectant solution has been sitting between 6 to 10 hours, drain, rinse and wipe the basin dry with a clean paper towel.
- (3) Record this procedure in the pedicure-cleaning log. The log shall contain the date and time of each cleaning, initials of the person who completed the procedure, and shall indicate that the cleaning was done weekly.

The pedicure-cleaning log shall be made available upon request by either a patron or a state board representative.

A violation of this section may result in an administrative fine and/or disciplinary action.

CAUTION: Cleaning products that contain abrasives can damage the pedicure spa. Use only non-abrasive products to clean your spa.





REMOVING / REPLACING DRAIN HANDLE

Tools required:

Phillips head screwdriver

Check your state and local regulations for cleaning procedures. Links to your state boards can be found on our web site, at www.europeantouch.com. Refer to the cleaning procedure page headed "Clean Touch™ Pipe-Free® Spa - Cleaning and Disinfecting Procedures," page 18, for cleaning recommendations.



Follow the steps below for cleaning and replacing parts:

 <p>Step 1: To remove the chrome handle pull it forward. If difficult to remove, gently pry it off with the screwdriver.</p>	 <p>Step 3: Adapter and Chrome Handle removed, shown for cleaning reference.</p>
 <p>Step 2: To remove the handle adapter, place Phillips head screwdriver into upper slot to reach screw, as shown in picture above. Unscrew and then pull adapter forward.</p>	 <p>Step 4: Drain Plunger removed, shown for cleaning reference.</p>

REMOVING / REPLACING IMPELLER

Check your state and local regulations for cleaning procedures. Links to your state boards can be found on our web site, at www.europeantouch.com. Refer to the cleaning procedure page headed "Clean Touch™ Pipe-Free® Spa - Cleaning and Disinfecting Procedures," page 18 for cleaning recommendations.

Follow the steps below for cleaning and replacing parts:

		
<p>1. Remove the Clean Touch Assembly by turning it clockwise</p>	<p>2. Remove Clean Touch inlet cover from housing by twisting counter-clockwise.</p>	<p>3. Remove the impeller by lifting from the basin. 4. Once the parts are clean, complete steps one through three in reverse order.</p>

HISTORY AND NOTES

HISTORY AND NOTES



EUROPEAN TOUCH™

**EUROPEAN TOUCH
8301 W. Parkland Court
Milwaukee, WI 53223**

**Phone Number: 1-414-357-7016
Toll Free: 1- 800-626-6912
Fax: 1- 414-357-6360**

Web Site: www.europeantouch.com